



BMP[®]41 LABEL PRINTER
USER'S MANUAL

Copyright

This manual is copyrighted with all rights reserved. No portion of this manual may be copied or reproduced by any means without the prior written consent of BRADY Worldwide, Inc.

While every precaution has been taken in the preparation of this document, BRADY assumes no liability to any party for any loss or damage caused by errors or omissions or by statements resulting from negligence, accident, or any other cause. BRADY further assumes no liability arising out of the application or use of any product or system described, herein; nor any liability for incidental or consequential damages arising from the use of this document. BRADY disclaims all warranties or merchantability of fitness for a particular purpose.

Trademarks

BMP[®]41 Label Printer is a trademark of BRADY Worldwide, Inc.

Microsoft and Windows are registered trademark of Microsoft Corporation.

BRADY reserves the right to make changes without further notice to any product or system described herein to improve reliability, function, or design.

© 2013 BRADY Worldwide, Inc. All Rights Reserved
Printed April 2013
Software Version 2

Brady Worldwide Inc.
6555 West Good Hope Road
Milwaukee, WI 53223 U.S.A.
Telephone: 414-358-6600 USA Domestic
Facsimile: 414-438-6958

UNITED STATES

Note

This equipment has been tested and found to comply with the limits for a Class A digital device, pursuant to part 15 of the FCC Rules. These limits are designed to provide reasonable protection against harmful interference when the equipment is operated in a commercial environment. This equipment generates, uses, and can radiate radio frequency energy and, if not installed and used in accordance with the instruction manual, may cause harmful interference to radio communications. Operation of this equipment in a residential area is likely to cause harmful interference in which case the user will be required to correct the interference at his own expense.

Changes or modifications not expressly approved by the party responsible for compliance could void the user's authority to operate the equipment.

INDUSTRY CANADA

This Class A digital apparatus meets all requirements of the Canadian Interference-Causing Equipment Regulations.

Cet appareil numérique de la classe A respecte toutes les exigences du Règlement sur le Matériel Brouilleur du Canada.

EUROPE



WARNING

This is a Class A product. In a domestic environment, this product may cause radio interference in which case the user may be required to take adequate measures.



Waste Electrical and Electronic Equipment Directive

In accordance with the European WEEE Directive, this device needs to be recycled in accordance with local regulations.

RoHS Directive 2011/65/EU

This statement clarifies Brady's product compliance with the European Union's Directive 2011/65/EU, Restriction of Hazardous Substances in electrical and electronic equipment.

Batteries Directive 2006/66/EC

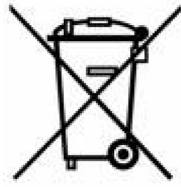

This product contains a lithium battery. The crossed-out wheeled bin shown to the left is used to indicate 'separate collection' for all batteries and accumulators in accordance with European Directive 2006/66/EC. Users of batteries must not dispose of batteries as unsorted municipal waste. This Directive determines the framework for the return and recycling of used batteries and accumulators that are to be collected separately and recycled at end of life. Please dispose of the battery according to your local regulations.

Notice to Recyclers

To remove the lithium battery:

1. Disassemble printer and locate the lithium cell battery located on the main circuit board.
2. To remove, push down on the center tab of the battery retainer, remove the battery from the board, and dispose of in accordance with local regulations.

To remove the NiMH battery:

1. Turn the printer over, open the battery compartment door, and remove the NiMH battery.
2. Release the battery from the printer and dispose of in accordance with local regulations.

BRADY Warranty

Our products are sold with the understanding that the buyer will test them in actual use and determine for him or herself their adaptability to his/her intended uses. BRADY warrants to the buyer that its products are free from defects in material and workmanship, but limits its obligation under this warranty to replacement of the product shown to BRADY's satisfaction to have been defective at the time BRADY sold it. This warranty does not extend to any persons obtaining the product from the buyer.

THIS WARRANTY IS IN LIEU OF ANY OTHER WARRANTY, EXPRESSED OR IMPLIED INCLUDING, BUT NOT LIMITED TO ANY IMPLIED WARRANTY OF MERCHANTABILITY OR FITNESS FOR A PARTICULAR PURPOSE, AND OF ANY OTHER OBLIGATIONS OR LIABILITY ON BRADY'S PART. UNDER NO CIRCUMSTANCES WILL BRADY BE LIABLE FOR ANY LOSS, DAMAGE, EXPENSE OR CONSEQUENTIAL DAMAGES OF ANY KIND ARISING IN CONNECTION WITH THE USE, OR INABILITY TO USE, BRADY'S PRODUCTS.

YOU SHOULD CAREFULLY READ THE FOLLOWING TERMS & CONDITIONS OF THIS LICENSE AGREEMENT. IF YOU DO NOT AGREE WITH THESE TERMS & CONDITIONS, PLEASE PROMPTLY RETURN THIS PACKAGE FOR A FULL REFUND.

Technical Support

Technical Support Numbers/On-line Help

For repair or technical assistance, find your regional Brady Tech Support office by going to:

- In the Americas: www.bradyid.com
- In Europe: www.bradyeurope.com
- In Asia: www.bradycorp.com

Repair and Replacement Parts

Brady Corporation offers repair and replacement services. Contact Brady Technical Support for repair and replacement information.

Table of Contents

Introduction	1
Unpack Your Printer	2
Save Your Packaging	2
Register Your Printer	2
BMP®41 Label Printer System Specifications	3
Physical and Environmental Characteristics	3
Firmware Upgrades	4
External View	5
Power Source	6
Loading the BMP41-BP NiMH Battery Pack	8
AC Power Adapter	9
Brady AC Adapters	9
Attaching the Adapter	9
Connecting	10
Connecting to a PC	11
Download Print Drivers	11
Pause/Cut Preference	11
Media Cartridge	13
Load Cartridge	13
Unload Cartridge	14
Power On	15
Display Screen	16
Status Information	16
Keypad	17
Navigation and Editing Keys	17
Function Keys	20
Menus	22
Dialog Boxes	23
Drop Down Field Lists	24
Data Fields	25
Spinner Boxes	26
Radio Buttons and Option Boxes	27
Accept Dialog Box Edits	27
Cancel a Menu or Dialog Box	27

Setup	28
Pause/Cut	28
Config	29
Time/Date	30
Units	30
Language	31
Initial Language Setup	31
Font Settings	31
Getting Started	33
Entering Text	33
Editing Text	33
Inserting Text	33
Deleting Text	34
Clear	34
Error Messages	35
Default Settings	35
Font Size	36
Printing a Label	37
Formatting	39
Font	39
Size	40
Font Attributes	41
Expand/Condense	43
Superscript/Subscript	44
Multi-Characters	44
Symbols	45
Remove a Symbol	46
Date and Time	47
Labels and Areas	48
Fixed Length	49
Add Areas	50
Go To An Area	50
Shortcut	50
Delete Area	51
Justification	52
Rotate	53
Frame	55
Reverse	56
Vertical Text	57
Barcode	59
Barcode Settings	59
Add a Barcode	60
Edit Barcode Data	62

Serialization	63
How Serialization Works	63
Examples of Serialization	64
Numbers in Sequences	65
Add Serialization	66
Edit a Sequence	68
File Management	69
File Naming Standards	69
Save	69
Remove File from Screen	73
Open a File	74
Delete a File	76
Printing	79
Cancel a Print Job	79
Print Preview	80
Scrolling in Print Preview	81
Multi-Print	82
Collate	82
Mirror Print	84
Label Types	85
Accessing a Label Type	85
General Label Type	87
WireMarker	88
Terminal Block, Patch Panel, 66 Block	90
Flags	92
110-Block, Bix Block Label Type	94
DesiStrip	97
Troubleshooting	99
Cleaning the Printer	104
Display Screen	104
Internal Components	104
Appendix A - Symbols	105

Introduction

The BMP[®]41 Label Printer is capable of printing on a variety of both die-cut and continuous supplies, up to 1 inch (25.4 mm) wide. It includes the following features:

- Targeted applications to simplify the creation of specific label types
- Battery operation - printing 1000 or more standard Brady die cut labels on a fully charged Brady battery pack.

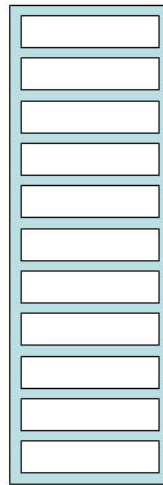

Figure 1 • Die cut label strip

- Ability to use the printer while the BMP41-BP NiMH battery pack is charging
- Large display (240 x 160 pixels; 50.39 x 33.59 mm)
- Easy to use graphic user interface
- 300 dpi print resolution
- USB 2.0
- One step media installation
- Smart-cell technology that works intelligently with Brady consumables

Unpack Your Printer

The following items are included in the standard BMP®41 Label Printer package:

- BMP®41 Label Printer
- BMP41-BP NiMH Battery Pack (M41-BATT)
- MC1-1000-595-WT-BK cartridge
- USB connection cable (M41-USB)
- AC adapter (M41-AC)
- Product CD
- Brady Printer Drivers CD
- Quick Start Guide



The following items are accessories available for the BMP®41 Label Printer:

- Hard-sided carrying case (M41-HC)
- BMP41-BP NiMH Battery Pack (M41-BATT)
- Magnet (M41-MAGNET)

These items can be purchased separately or as a kit from your distributor.

Save Your Packaging

The packaging surrounding your BMP®41 Label Printer should be saved in the event you have to ship the printer and accessories back to the supplier.



WARNING

Never ship the BMP®41 Label Printer without first removing the BMP41-BP NiMH battery pack from the printer.

If shipping both the printer and battery pack, remove the battery pack from the printer and place the items in the original shipping material before transporting. Batteries must be shipped according to state, federal, or municipal regulations. Consult your courier before shipping NiMH battery packs.

Register Your Printer

Register your printer on-line at www.bradycorp.com/register and receive free product support and updates!

BMP[®]41 Label Printer System Specifications

The BMP[®]41 Label Printer has the following specifications:

- Weight 2.6 lbs (1.2 kg)
- Thermal Transfer Print Mechanism 300 dpi
- Optical Registration System for Precise Print Registration
- Softplast QWERTY Keypad Technology
- Custom True Type Fonts
- Print Width - 1 inch (25.4 mm) maximum label width
- Maximum print length for labels: 39" (990.6 mm)
- Prints up to 1000 1" x 2" labels per battery charge

Physical and Environmental Characteristics

The BMP[®]41 Label Printer has the following physical and environmental characteristics:

Physical	Metric Units	U.S. Units
Dimensions	292 x 91 x 152 mm	11.5 x 3.6 x 6 in.
Weight (with battery pack)	1.2 kg	2.6 lbs

Note: The table below refers to the BMP[®]41 Label Printer only. Consumable performance may vary.

Environmental	Operation	Storage
Temperature* (Printer)	4° to 43° C (40° to 110° F) Be mindful, when using the AC adapter with the printer, that the AC adapter is rated at a maximum temperature of 30° C (86° F).	-18° to 43° C (0° to 110° F)
Relative Humidity (Printer)	20% to 90% (non-condensing)	10% to 90% (non-condensing)

*Exposing the BMP[®]41 Label Printer to direct sunlight is not recommended.



WARNING

Avoid using the system near water, in direct sunlight, or near a heating device.

Do not attempt to use batteries other than those recommended in this manual.

Firmware Upgrades

Future upgrades to BMP[®]41 Label Printer firmware can be downloaded from Brady's website. Access www.bradyid.com/BMP41, click Support>Downloads, then select BMP[®]41 Label Printer from the list of products.

External View



1 Power key

2 Function keys

3 Print key

4 Feed key

5 Navigation pad with ENTER key

6 Thumb Drive-Port

7 AC Adaptor Port

8 USB port

Power Source

Power is supplied to the BMP®41 Label Printer through a BMP41-BP NiMH battery pack, or through an AC power adapter.



WARNING

Do not expose batteries to temperatures above 60C (140F).

Do not disassemble or mistreat the battery pack.

Do not attempt to open, damage, or replace components in the battery pack.

The Battery Pack should only be used in the BMP®41 Label Printer.

Do not use any other rechargeable battery pack other than the BMP-UBP in the BMP®41 Label Printer.

Do not allow metal or other conductive materials to touch the battery terminals.



WARNING

Keep the battery pack away from sparks, flames, or other heat sources.

Keep the battery pack away from water.

Never lay objects on top of the battery pack.

Store your battery pack only in a cool, dry place.

Keep the battery pack out of the reach of children.

Special precautions should be taken when handling these cells during disposal to prevent impact to the cells.

The battery pack must be recycled or disposed of properly according to federal, state, and municipal regulations.

**WARNING**

Do not dismantle, open or shred secondary cells or batteries.

Do not expose cells or batteries to heat or fire. Avoid storage in direct sunlight.

Do not short-circuit a cell or a battery. Do not store cells or batteries haphazardly in a box or drawer where they may short-circuit each other or be short-circuited by other metal objects.

Do not remove a cell or battery from its original packaging until required for use.

Do not subject cells or batteries to mechanical shock.

In the event of a cell leaking, do not allow the liquid to come in contact with the skin or eyes. If contact has been made, wash the affected area with copious amounts of water and seek medical advice.

Do not use any charger other than that specifically provided for use with the equipment.

Observe the plus (+) and minus (-) marks on the cell, battery and equipment and ensure correct use.

Do not use any cell or battery which is not designed for use with the equipment.

Do not mix cells of different manufacture, capacity, size or type within a device.

When using alkaline cells, always use fresh, new batteries and never mix used batteries with new batteries.

Keep cells and batteries out of the reach of children.

Seek medical advice immediately if a cell or a battery has been swallowed.

Always purchase the correct cell or battery for the equipment.

Keep cells and batteries clean and dry.

Wipe the cell or battery terminals with a clean dry cloth if they become dirty.

Secondary cells and batteries need to be charged before use. Always use the correct charger and refer to the manufacturer's instructions or equipment manual for proper charging instructions.

Do not leave a battery on prolonged charge when not in use.

After extended periods of storage, it may be necessary to charge and discharge the cells or batteries several times to obtain maximum performance.

Secondary cells and batteries give their best performance when they are operated at normal room temperature ($20\text{ }^{\circ}\text{C} \pm 5\text{ }^{\circ}\text{C}$).

Retain the original product literature for future reference.

Use only the cell or battery in the application for which it was intended.

When possible, remove the battery from the equipment when not in use.

Loading the BMP41-BP NiMH Battery Pack

If using a BMP41-BP NiMH battery pack, please consult the instructions enclosed with the battery pack for charging and discharging the rechargeable battery.

1. On the backside of the printer, pull the door release latch downward, then swing the battery compartment door up and out. (The door will come off.)
2. With the battery label facing outward, insert the battery pegs into the peg slots at the top of the compartment; then tip the battery downward into place.
3. Re-insert the battery door hinges at the base of the compartment and swing the battery compartment door closed, snapping it into place.



AC Power Adapter

The printer can be powered through an AC/DC power adapter. If the battery pack is installed when using the power adapter, the battery will charge.



WARNING

Use only the 18 VDC, 3.3A, Brady AC/DC adapters, shown below, for supplying power to the BMP®41 Label Printer.

Brady AC Adapters

Catalog Number	Region
M50-AC	North America, Australia
M50-AC-INTL	Europe
M50-AC-AR	Argentina
M50-AC-BR	Brazil

Attaching the Adapter

The printer can be powered through a designated AC power adapter. When the adapter is plugged in, it will also charge the BMP41-BP NiMH battery pack if one is inserted in the battery compartment.

1. Insert the round end of the adapter cable into the plug-in port on the back of the printer.
2. Plug the other end of the cord into an electrical outlet.



Connecting

The BMP®41 Label Printer is equipped with a USB port, enabling you to connect via USB to a PC. You can create labels in various applications (such as LabelMark™ Labeling Software) and send the data to be printed on the BMP®41 Label Printer. You can also transfer files to be printed to the BMP®41 Label Printer by placing the files on a thumb drive which can be connected directly to the BMP®41 Label Printer.



1 | AC Adaptor Port
2 | USB port

3 | Thumb Drive-Port

Connecting to a PC

In order to send data from a Brady PC labeling program to the BMP[®]41 Label Printer, you must install the BMP[®]41 Label Printer driver. The printer drivers can be found on the Brady Printer Drivers CD enclosed with your BMP[®]41 Label Printer package.

To install the printer drivers:

1. Turn the printer on.
2. Insert the Brady Printer Drivers CD into the CD drive of your computer.

The printer drivers wizard is launched.

3. Follow the prompts on the screen for installation of a particular driver.

Note: If it appears that the printer has lost communication with the host computer while still connected via the USB cable, turn the printer off, then restart it to restore the connection.

Download Print Drivers

You can also download the print drivers from the Brady website at www.bradyid.com/bmp41. On the website, choose Support>Printer Drivers, then follow the instructions on the screen.

Pause/Cut Preference

After the printer driver is installed, access the printer and set the Pause/Cut preference.

1. In Windows XP, click Start, then choose Settings>Printers and Faxes.

OR

In Windows 7, click Start, then choose Devices & Printers.

OR

In Windows 8, using the Search feature in the Charms bar, search for Devices and Printers.

2. In the list of available printers, right click BMP41 and choose Printing Preferences.

The Layout tab of Printing Preferences displays.

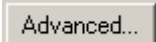
3. Click  button.

4. On the Advanced Options screen, click Properties button for Custom Settings.

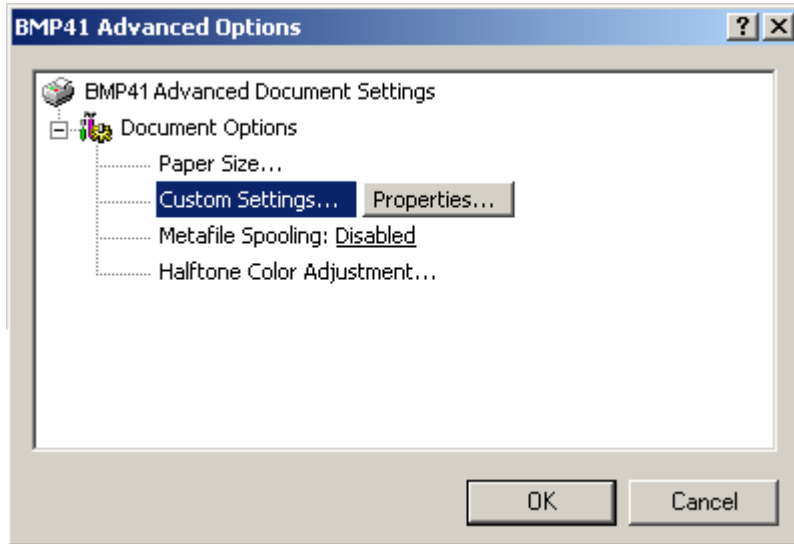

5. On the Custom Settings screen, click the down arrow in Cutter Option field and select if you want to pause the printer for cutting at the end of each label or at the end of the job.

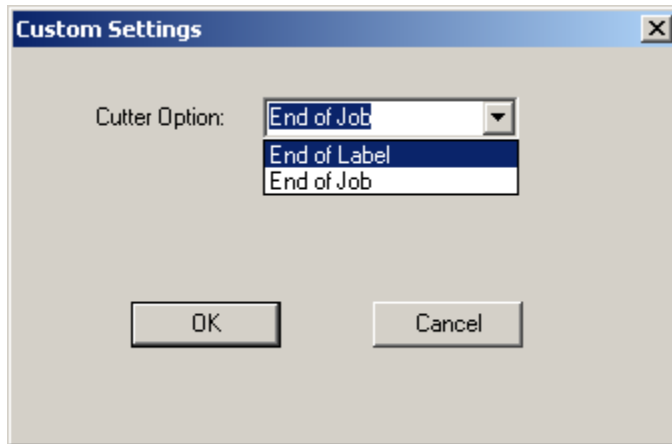

6. Click OK to accept the changes. (You may have to click OK a number of times as you back out of the Printing Preferences screens.)

Media Cartridge

The media and ribbon supplies for the BMP[®]41 Label Printer are combined in a plastic cartridge for easy one-step loading. To load the cartridge:

Load Cartridge

1. To open the printer cover, push or pull up on the finger tab.
2. Holding the hinged fin, drop the cartridge into the cartridge well, pushing gently until it snaps into place. Slide the locking lever to the right to lock the cartridge into place.

Close the cover by pushing down on it until it snaps into place.

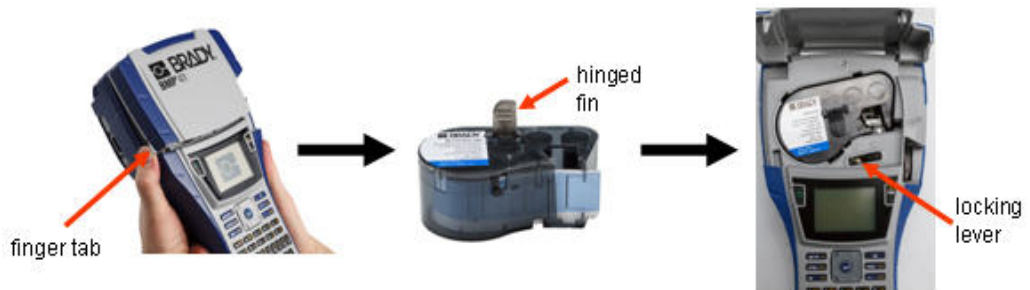

Although the printer can be operated with the cover open, it is recommended that the cover remain closed during printing and standby operation.

Unload Cartridge

To remove the media cartridge:

1. To open the printer cover, push or pull up on the finger tab.
2. To unlock the cartridge, slide the locking lever to the left.
3. On the back of the printer, push the round eject button to pop the cartridge up. Then, grasping the hinged fin, pull the cartridge out of the cartridge well.



If the cartridge is empty, recycle according to local regulations.

The media gauge at the bottom of the display screen indicates how much media remains. Store the cartridge in a cool, dry place. Unused media will last up to six months before deterioration sets in.



Please note that the cartridge bay contains parts and assemblies that may be susceptible to damage by Electrostatic Discharge (ESD). When loading or unloading a cartridge, care must be taken so that devices are not damaged.

Power On

To turn the system on or off:

1. Press **Power**



To preserve battery life, when the printer detects a time of inactivity, it automatically shuts down. Any data on the screen at the time of auto shutdown is retained and available the next time the **[Power]** key is pressed to restart the printer. (See [page 29](#) for information on setting the shut off delay time.)

The first time the printer is turned on, you may want to choose a language in which to display screen items. Language selection is performed in the Setup function. (For more information, see “Setup Language” on [page 31](#).)

Whenever the printer is powered on, the system performs an initialization process. Part of this process is recognizing the media installed. While it is possible to power on the printer without installing media, if you choose not to install any, the printer reverts to the last media installed in the printer.

Display Screen

The display screen enables you to view font attributes and other formatting features directly on the screen while you are entering and editing data.

The screen displays one label, or one area on a multi-area label, at a time. For labels with multiple areas, use Print Preview (see [page 81](#)) to view all areas together.

Status Information



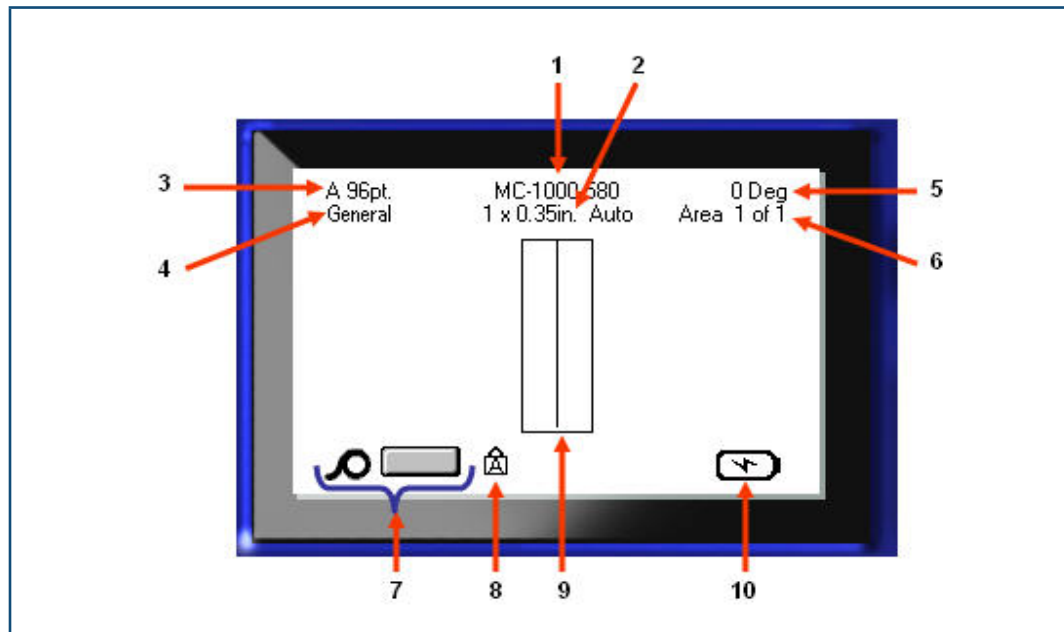



A status bar displays permanently at the top and bottom of the screen and contains the following:











- | | | | |
|---|-------------------------------------|----|--------------------------------------|
| 1 | Label part number | 6 | Number of areas on current label |
| 2 | Label size | 7 | Media remaining |
| 3 | Font size, with Auto size indicator | 8 | Indicates CAPS Lock is on |
| 4 | Label type | 9 | Editor window |
| 5 | Degree of rotation | 10 | Battery charging/or charge remaining |

Keypad



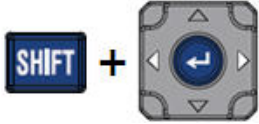
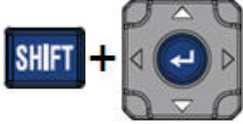

Navigation and Editing Keys





Function	Key	Description
Navigation Keys		<p>Navigation keys:</p> <ul style="list-style-type: none"> • In a line of text, move the cursor left or right a character at a time, or up and down a line at a time. • In menus, move the selection left or right in a primary menus; up or down through a secondary, or sub-menu. • In a dialog box, move up/down or left/right through the fields. In a field with a drop down list, after pressing OK, moves the cursor up or down through the list. • In Print Preview, scrolls left or right through multiple areas on a label.
ENTER Key		<ul style="list-style-type: none"> • Adds a new blank line to a label. • Accepts menu items and attributes.
Alternate Function Key		<ul style="list-style-type: none"> • Used in conjunction with the alternate function (displayed in gold) on some of the keys. Press the FN key, then press the alternate function key. OR Hold the FN key while simultaneously pressing the key that has the alternate function. • Used to access special characters on the alphabetical keys.
Backlight Key	 +  	Increases readability of screen in low light conditions.

Function	Key	Description
Backspace Key		<ul style="list-style-type: none"> Removes characters one at a time, moving to the left. Backs out of menu options and functions, one screen at a time. <p>Note: Depending on how deep you are into menus and functions, you may have to press Backspace multiple times.)</p>
Caps Lock Key		Acts as a toggle to lock text into uppercase as data is entered.
Clear Key		Clears data from the screen.
Superscript Key		<ul style="list-style-type: none"> Places the next typed character in superscript format, displaying slightly above the line of text. Will place multiple characters in superscript if the characters are highlighted first. (Refer to page 42 for information on highlighting characters.)
Subscript Key		<ul style="list-style-type: none"> Places the next typed character in subscript format, displaying slightly below the line of text. Will place multiple characters in subscript if the characters are highlighted first. (Refer to page 42 for information on highlighting characters.)
Move to Next Area Key		On a multi-area label, moves to the next area from the current area.
Move to Previous Area Key		In a multi-area label, moves to the previous area from the current area.

Function	Key	Description
Highlight Text		Highlights (selects) text on the editing screen, left or right a character at a time, enabling you to add font attributes (bold, italics, underline) to text already entered. Hold the [SHIFT] key while pressing the left or right navigation key.
Font Size Increment		On the editing screen, increases or decreases the font size, a point at a time. Hold the [SHIFT] key while pressing the up or down navigation key.
Decimal Point		Adds a decimal point or period.

Function Keys

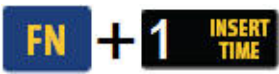
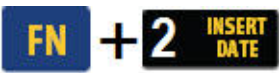
Function	Key	Description
Setup Key		Defines the printer's default parameters.
Print Preview Key		Previews the label as it will look when printed.
Serial Key		Sets the values for single, multiple, or linked serialization.
Label Settings Key		Provides formatting that affects the entire label (e.g., centering data on the label, framing the label, rotating data).
File Key		Saves, opens, or deletes a label.
Label Type Key		Accesses the different applications/label types installed (i.e., wiremarker, flags, terminal blocks, etc.).
Font Key		Provides font sizes and attributes (such as bold and italics).
Print Key		Prints all labels in a label file.
Multi-Print Key		Brings up options to set various print parameters (such as number of copies, print range, and mirror print) before printing.
Feed Key		Feeds the media through the printer.
Symbol Key		Accesses the various symbols (graphics) available in the printer.

Function	Key	Description
Barcode Key		Places a text string in Barcode format, toggling the barcode on and off.
International Key		Accesses characters specific to some international alphabets with diacritical and accent marks incorporated into the characters.
Insert Time Key		Inserts the current time, as set on the printer.
Insert Date Key		Inserts the current date, as set on the printer.
Area Key		Adds, removes, and formats areas on a label.

Menus

Menus display at the bottom of the screen and are activated by the function keys (the set of keys to the left of the display). Use navigation keys to access the different menu items. Continue to press the navigation keys to access the overflow menus. When you have reached the last menu item displayed, the menu cycle back to the first menu item.

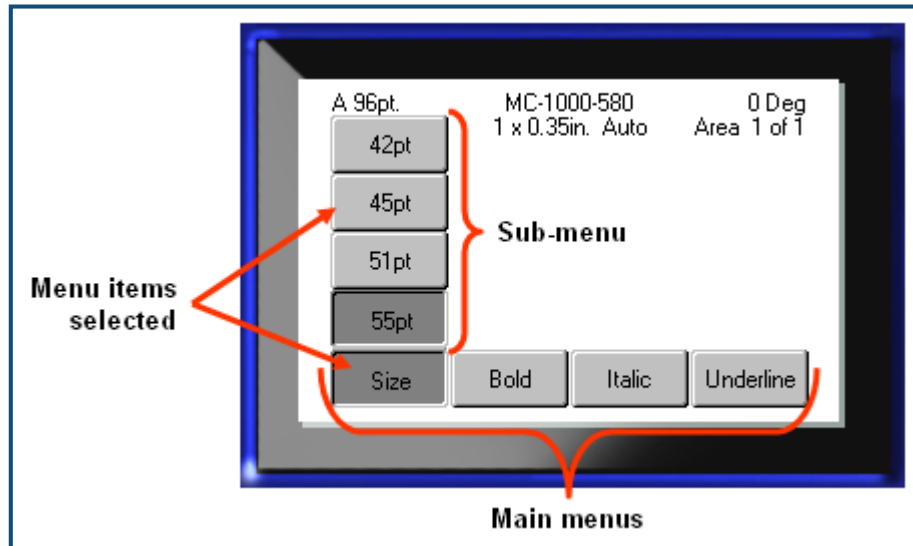

Figure 2 • Menus

To access the menus:

1. Press the Function key for the menu you want to access.

The menu choices for that particular function display.

2. Press the left/right navigation keys to access the main menu items.

As you navigate over a menu item, if a sub-menu is available, it immediately pops-up.

To access a sub-menu:

3. Press the up/down navigation keys.

An accessed menu displays as a depressed button with a darker shade of gray.

4. To activate the highlighted sub-menu, press Enter .

A menu option remains in effect until a different menu option is activated.

The various functions and menus are discussed in further detail in the Formatting section of this manual, starting on [page 39](#).

Dialog Boxes

Some function keys display dialog boxes, rather than sub-menus.

Note: You will know that a dialog box is associated with a menu if a sub-menu does not immediately pop up when highlighting the main menu option.

To access the dialog box, with the desired main menu selected:

1. Press Enter .

A dialog box displays.

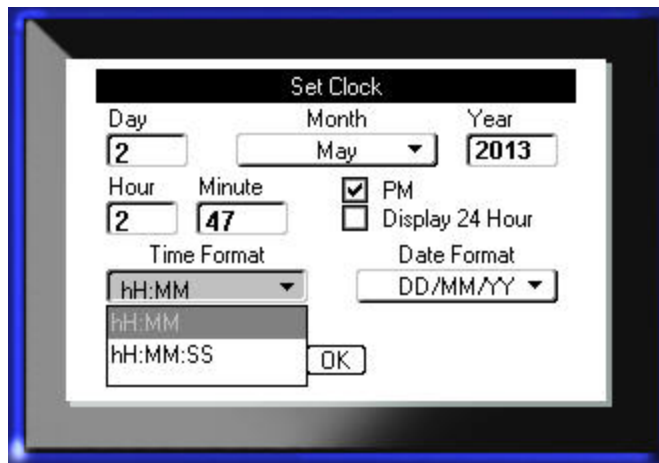



Figure 3 • Dialog box

2. Press the up/down and left/right navigation keys to move to the different fields.

An activated field displays in a darker shade of gray.

Drop Down Field Lists

If a field has a drop down list associated with it, a downward facing arrow displays on the right side of the field. To select an option from the drop down list:

1. Press Enter  to open the drop down list.
2. Use up/down navigation keys to highlight the desired option.
3. Press Enter  to select the option.

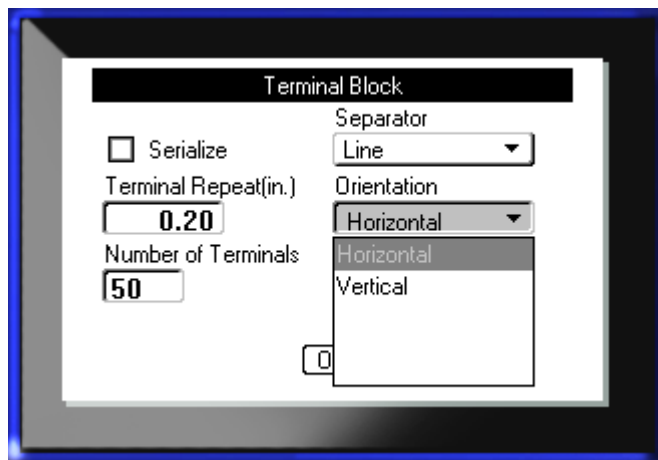
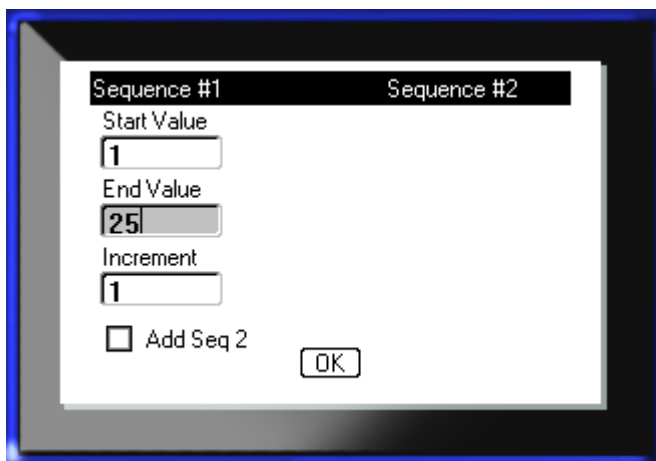

Figure 4 • Drop down fields

Data Fields

In fields requiring user-supplied data:

1. Using navigation keys, navigate to the data field.
2. Enter data using the keyboard.
3. Use navigation keys to move off the field after entering data.





The image shows a dialog box with a white background and a blue border. At the top, there are two tabs: "Sequence #1" and "Sequence #2". Below the tabs, there are four input fields: "Start Value" with the number "1", "End Value" with the number "25", and "Increment" with the number "1". At the bottom left, there is a checkbox labeled "Add Seq 2" which is currently unchecked. At the bottom right, there is an "OK" button.

Figure 5 • Data input fields

Spinner Boxes

A spinner box lets you toggle through a range of values in a field. To use a spinner box:

1. Navigate to the field containing the spinner box.
2. Press Enter .
3. Use the up/down navigation keys to toggle through the range of values.
4. When the desired value is reached, press Enter .

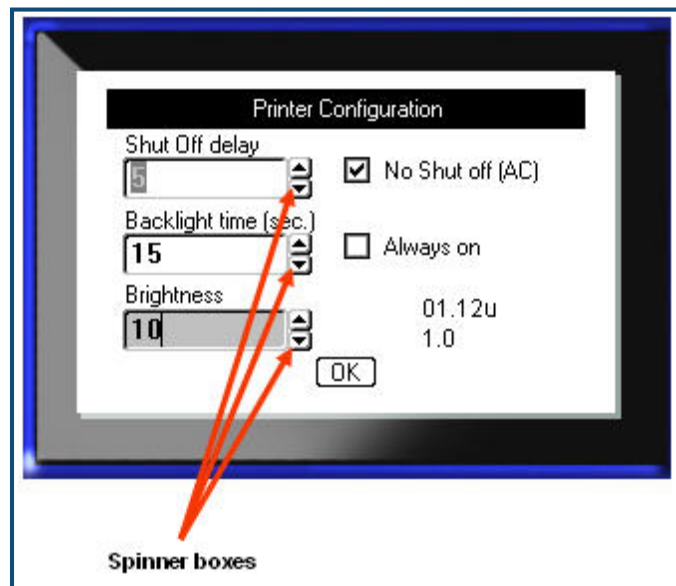

Figure 6 • Spinner boxes

Note: Some fields containing spinner boxes allow you to type numbers directly in the field. The presence of a cursor in the field indicates you can directly enter numbers.

Radio Buttons and Option Boxes

To check or uncheck a radio button or option box:

1. Navigate to the desired option.

2. Press Enter .

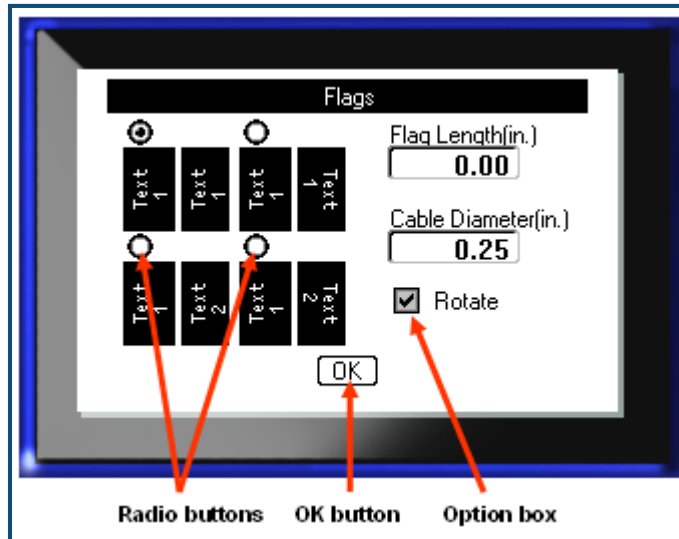



Figure 7 • Radio buttons, Option boxes and OK button

Accept Dialog Box Edits

To accept all edits in a dialog box:

1. Navigate to  at the bottom of the dialog box.

2. Press Enter .

Cancel a Menu or Dialog Box

To cancel a menu or dialog box, without accepting changes:

1. Press Backspace .

Setup

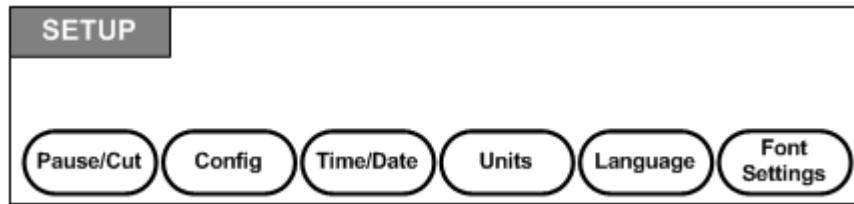





Figure 8 • Setup menu options

The Setup function key is used to determine the default settings for the printer. To change Setup functions:

1. Press Setup  + .
2. Using navigation keys, choose the setup function to change.
3. Press Enter .

If a dialog box is associated with the specific Setup function, it displays upon pressing OK.

Pause/Cut

The Pause/Cut function allows you to remove a label from the printer before another label starts printing. If this feature is turned on, when printing a string of labels, cutting a label initiates the next label to print. To turn on the Pause/Cut function:

1. Press Setup  + .

The Pause/Cut menu, being first in the list of primary menus, is already selected.

2. Using navigation keys, choose **Pause/Cut>On**.
3. Press Enter .

Note: Your Pause/Cut preferences, whether to pause the printer for cutting after each label or at the end of the job, must be set in the printer's properties. Refer to [page 11](#) of this document for information on setting these preferences.

Config

The following settings can be found under the Config menu in the Setup function.

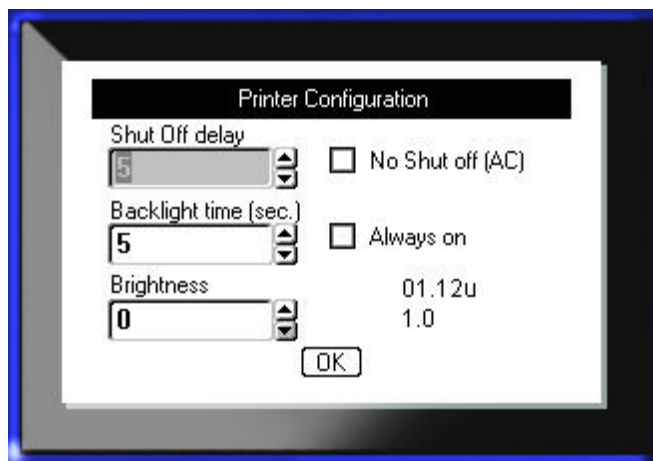

Figure 9 • Printer configuration in Setup settings

The Shut Off Delay sets the auto-off time-out. This refers to the number of minutes of inactivity after which the printer automatically shuts off.

When using the AC adapter, power is constant so there is no drain on the battery. In this case, you can turn off the Shut Off Delay by choosing No Shut off (AC).

The Backlight time (sec.) sets the backlight auto-off time-out. This refers to the number of seconds of inactivity after which the backlight automatically shuts off.

If you prefer to keep the backlight on at all times while using the AC adapter, choose Always on.

The Brightness setting increases or decreases the brightness of the display screen.

Time/Date

The following settings can be found under the Time/Date menu in the Setup function. Set the Time/Date options upon initial start-up of the printer.

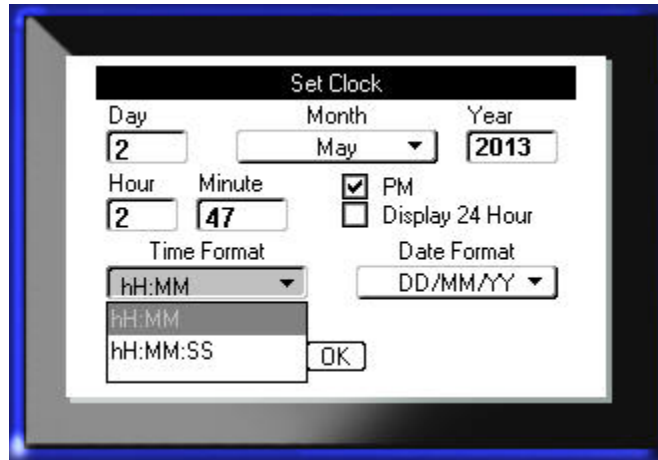

Figure 10 • Time/Date settings in Setup function

Units

The Units setting is used to configure label parameter measurements for the printer. The units are:

- Inches
- Millimeters

Once configured, you do not have to indicate “inches” or “millimeters” (or their globally accepted abbreviations or marks) when entering numbers in data fields. Likewise, in any scale or range of measurement field (using spinner boxes or in a drop down list), the range of measurements will automatically configure to the units selected in the Setup function.



Language

The following languages can be found under the Language menu in the Setup function.

English	Norwegian
French	Finnish
Spanish	Swedish
German	Italian
Portuguese	Danish
Dutch	

Initial Language Setup

When turning the printer on for the first time, immediately go to the Setup function and choose the language in which you want all printer menus, functions, and data displayed.

1. Press Setup  + .
2. Using navigation keys, choose **Language**>*desired language*.
3. Press Enter  to accept the choice.

Font Settings

Use Font Settings to set the default font and to indicate font size measurement (points or millimeters). You can also set default font attributes.

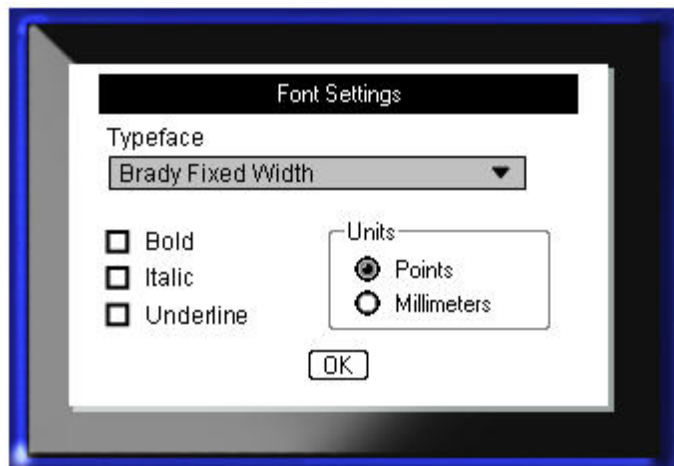

Figure 11 • Font settings in Setup function

This page intentionally left blank.

Getting Started

This section describes the process of creating a text label with minimal formatting, using basic editing techniques, and printing the label.

Entering Text

Before entering label text, be sure the media cartridge is loaded and the power is ON.

The vertical bar on the display screen is the cursor and is the starting point for every label you create using the BMP[®]41 Label Printer. Begin entering text at the position of the cursor. The cursor moves across the screen as you enter data. If you want another line of text, press [ENTER] .

Editing Text

If you have entered some text in error or want to change the content or format of your label, edit the information before printing.

Inserting Text

To insert additional text within a line of text:

1. Using navigation keys, position the cursor at the point where text should be inserted.
2. Enter the text.

Existing data positioned to the right of the cursor moves progressively to the right to make room for the inserted text. If a fixed font size is selected, when the end of the line is reached, no more data can be inserted. To add more data, press [ENTER]  to start another line or decrease the size of the font.

Deleting Text

To remove characters, one at a time, from the position of the cursor TO THE LEFT (backwards):

1. Press Backspace .

Clear

[CLEAR] is used to clear data from the screen or cancel a function.

Clear Data

To Clear data:

1. Press Clear  + .

You are presented with two options:

- Clear Text
- Clear All

Clear Text removes all data on the label, but leaves the formatting in place (e.g., font size, number of areas, etc.)

Clear All removes all data and formatting from the label.

2. Choose the desired option.

3. Press Enter .

If using Clear All, a message displays asking confirmation.



4. Press Enter  to confirm the deletion.

If you do not want to delete the labels:

5. Press Backspace  to cancel the Clear All function.

You are returned to the screen with all labels and data intact.

Cancel Functions

Backspace  is also used to cancel functions, a menu, or dialog box. When pressing Backspace in the middle of a function, you are walked out of the function a screen at a time. You may have to press Backspace several times to completely exit the function.

Error Messages

If a function does not operate under current conditions, an error or information message displays indicating the problem and/or offers situational advice. Read the message carefully and follow the instructions.

Default Settings

Default settings are determined by the printer for the installed media. When the label supply and/or application label type is reloaded, it will return to these settings.

Font Size

Font size is applied on a line-by-line basis. If the size is changed before the data is entered, all the data in the current and subsequent lines, takes on the new font size until font size is changed again.

Changing the font size on pre-entered data changes the size on the entire line, regardless of where the cursor is in the line. However, the font size will not change on subsequent lines of pre-entered data. You must change the font size on each individual line of pre-entered data.

Autosize

Autosize starts with the largest font size that fits on the label. When a line of text reaches the edge of a label it scales downward until you press [ENTER] or the minimum font size is reached. When working with autosize and multiple lines of text, all lines on a label maintain the same size.

By default, autosize is turned on for all labels and is displayed as an 'A' in the upper left corner of the Status Bar.

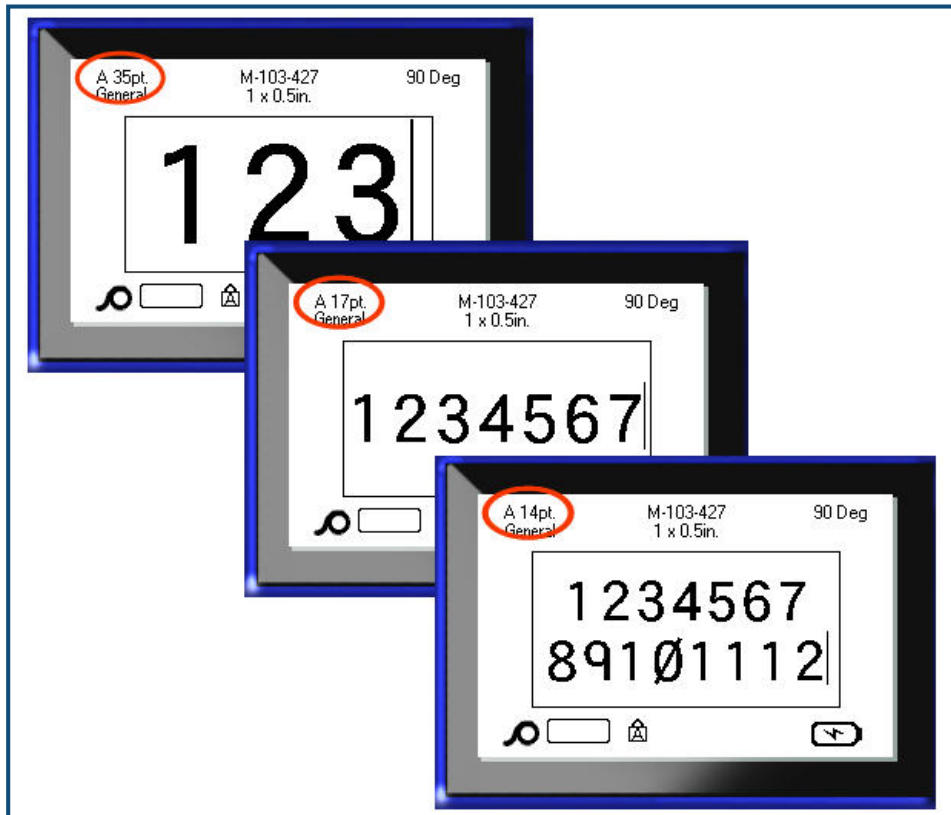

Figure 12 • Text entered with Autosize turned on

To turn autosize on (if not already on):

1. Press Font .
2. Choose **Size>Auto**.
3. Press Enter .

Autosize remains on for the entire area or label, until a different font size is selected. However, after being turned off, any previous text entered using autosize retains the size generated by autosize.

Printing a Label

To print a label:

1. Press Print .

When the cut label message displays:

2. Push the cutter lever down as far as it will go.

The message will not disappear if you have not fully cut through the label.



Note: If you manually clear the cut label message and continue to print, the partially cut label will cause a jam. Make sure the label is completely cut through before attempting to print again.

The label exit chute contains rubber grips that hold the label in place after cutting so it will not fall off.

3. Gently pull the label away from the label exit chute.

Printing from the BMP[®]41 Label Printer occurs in the background, meaning you can continue to edit or create new labels while a label is printing.

This page intentionally left blank.

Formatting

Formatting refers to the layout, structure, and appearance of a label. Different formatting features can be found under the Font, Label and Area functions.

Font

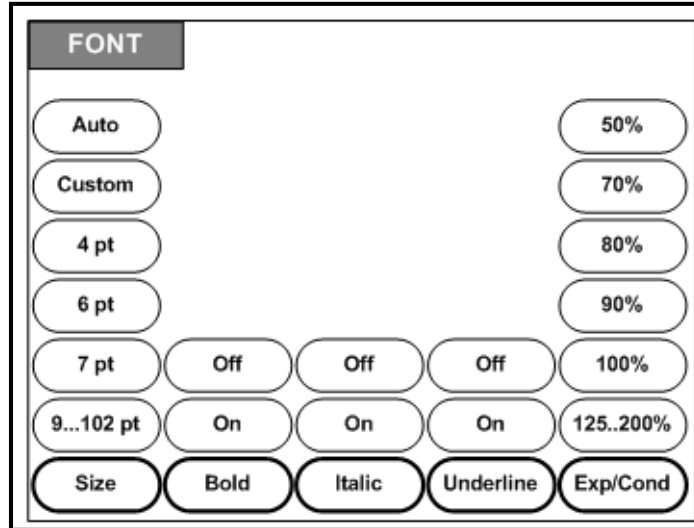

Figure 13 • Font menu options

Character/line formats are called attributes that change the appearance of the fonts, such as size, weight (bold), and angle (italics).

Size

Font size applies to an entire line of data at a time and is measured in point size or millimeters, as determined in the Setup function. To change the size of the chosen font:

1. Press Font  .

A sub-menu displays the available font sizes for the media installed.

2. Choose **Size**>*font size* desired.

3. Press Enter  .

Custom Size

If the desired size is not displayed, you can manually enter a font size within the valid size range. This option is available under “Custom” of the Size menu.

To manually enter a font size:

1. Choose **Custom** and enter the font size.

2. Press Enter  .

When entering a custom font size, a minimum/maximum range is presented to accommodate the label size loaded in the printer. The minimum size reflects readability and the maximum size accommodates proper fit on a label. If you enter a size smaller than the minimum or larger than the maximum, an error message displays indicating the entered size exceeds lower or upper limits.

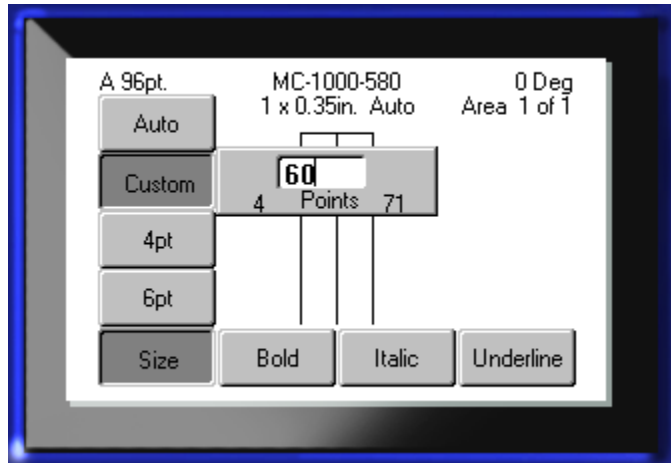

Shortcut



You can increase or decrease the size of the font, one point at a time using the navigation keys:

1. Hold the **[Shift]** key and press the Up/Down navigation keys enough times to reach the desired font size.

Font Attributes



Font attributes (bold, italics, underline) can be applied to individual characters in a line of text.

To turn an attribute on:

1. Position the cursor where the attribute should take affect.
2. Press Font  .
3. Choose the desired attribute, then choose **ON**.
4. Press Enter  .
5. Enter the text to be affected by the attribute.

The attribute stays on until it is turned off, or until you move to a new area.

To turn the attribute off:

1. Press Font  .
2. Choose the attribute, then choose **OFF**.
3. Press Enter  .



Pre-Existing Data

To apply an attribute to previously entered text:

1. Hold Shift  while pressing the left/right navigation keys to move the cursor across the characters on which the attribute will take affect.

This highlights the data.



Note: Highlighting works on a line-by-line basis. You cannot highlight more than one line at a time.

2. Press Font .
3. Choose the attribute, then choose **ON**.
4. Press Enter .

All highlighted text displays the attribute.

Note: To remove the highlighting from the characters, press any navigation key.

To remove an attribute that was previously applied to some text:

1. Hold Shift  while pressing the left/right navigation keys to move the cursor across the characters from which the attribute will be removed.
2. Press Font .
3. Choose the attribute, then choose **OFF**.
4. Press Enter .

The attribute is removed from the text.

Expand/Condense

Expanding and condensing data affects character width and the spacing between characters in a word. Data can be expanded or condensed according to predefined percentages.

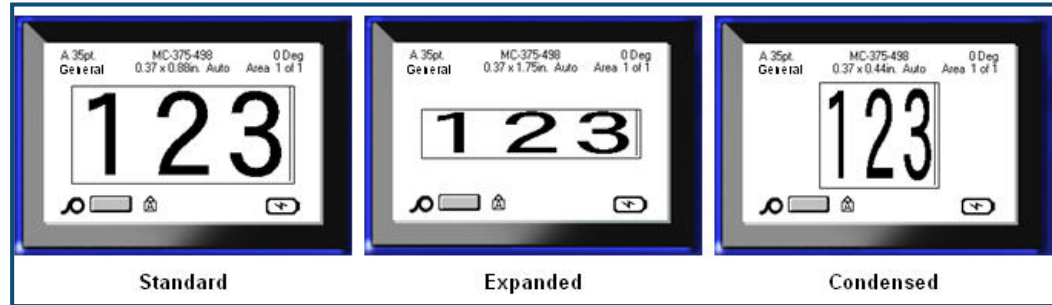



Figure 14 • Expanded and condensed text

To Expand or Condense data, as it is entered:

1. Position the cursor where Expand or Condense should take affect.
2. Press Font **FONTS** **CAPS**.
3. Choose **Exp/Cond**>*percentage* desired.
4. Press Enter .

While entering data, the expand or condense attribute stays on until it is returned to 100%, or until you move to a new area.

To expand or condense pre-existing data:

1. Hold Shift **SHIFT** while moving the cursor across the characters that are to be expanded or condensed.

This highlights the data.

2. Press Font **FONTS** **CAPS**.
3. Choose **Exp/Cond**>*percentage* desired.
4. Press Enter .

All highlighted text takes on the attribute.

Superscript/Subscript

Superscript places a character slightly above the line of type and subscript places a character slightly below. The super- or subscript character also displays slightly smaller than the normal line of type. Superscript and subscript functions are on the numeric keypad. Pressing either the superscript or subscript key applies that format to the next character typed. It immediately turns off after the character is entered and you are returned to the normal line of type.

To apply Superscript or Subscript:

1. Position the cursor in the line of text where the superscript or subscript character will display.

2. Press Super  +  or Sub  + .

3. Type the character to be displayed in superscript or subscript.

Only the character typed directly after pressing the superscript or subscript key is displayed in super- or subscript.

Multi-Characters

To place a number of characters in Super- or Subscript:

1. Enter the text that should display in super- or subscript.
2. Hold Shift  while moving the cursor across the characters that will display in super- or subscript.

This highlights the characters.

3. Press Super  +  or Sub  + .

All the highlighted characters display in super- or subscript.

4. To remove the highlighting, press any navigation key.

Symbols

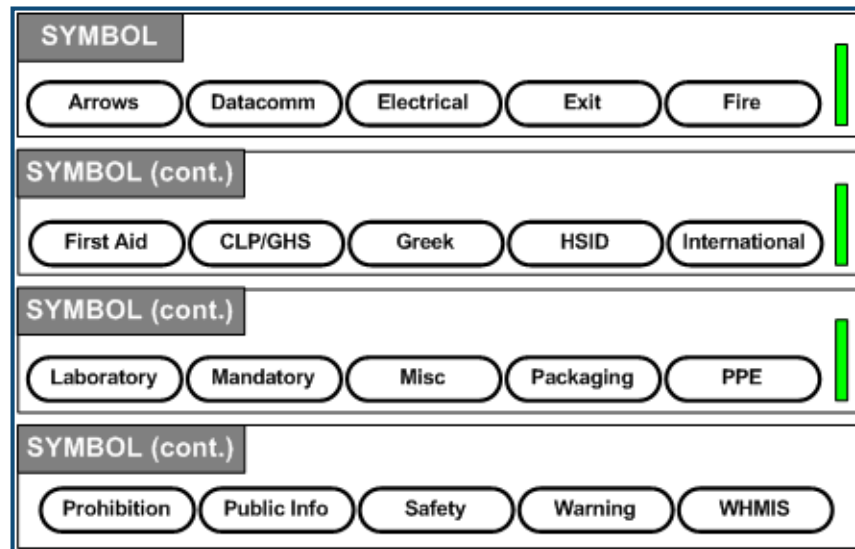





Figure 15 • Symbol categories

The BMP[®]41 Label Printer contains hundreds of symbols (graphics) that can be used for a variety of applications. To add a symbol to the label:

1. Position the cursor at the point where you want the symbol to display.
2. Press Symbol .
3. Navigate to the desired symbol category.

Note: When adding symbols, the printer will always return to the last symbol category used.

4. Press Enter  to pick the symbol category.
5. Using navigation keys, select the desired symbol.
6. Press Enter .

The symbol displays with the same font size that is currently in use.

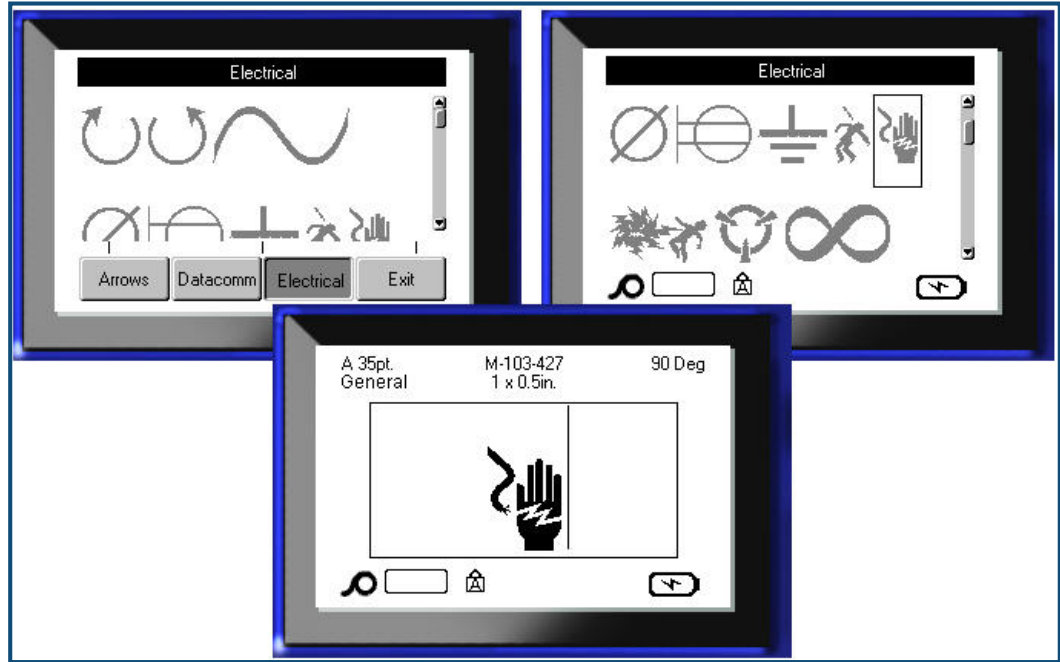

Figure 16 • Selecting a symbol

Remove a Symbol

The symbol is the same as any other character. To remove a symbol:



1. Position the cursor to the right of the symbol.



2. Press Backspace  CLEAR .

Date and Time

To have the current date and/or time inserted on each label:

1. Position the cursor at the point on the label where you want the date and/or time to be inserted.

2. To insert the date, press Insert Date  +  .

3. To insert the time, press Insert Time  +  .

The BMP41 printer inserts the current Date or Time data using the current system clock value at the time of printing and the date/time format defined in the Setup function. (For more information, see “Time/Date” settings on [page 30](#).)

Labels and Areas

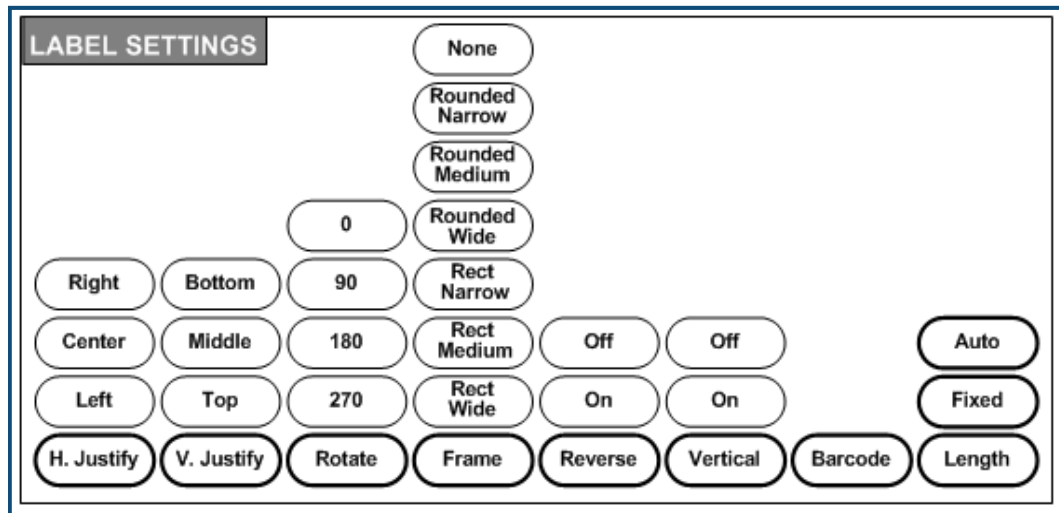

Figure 17 • Label Settings menu options

Label settings, with few exceptions, apply to the entire label, not individual data.

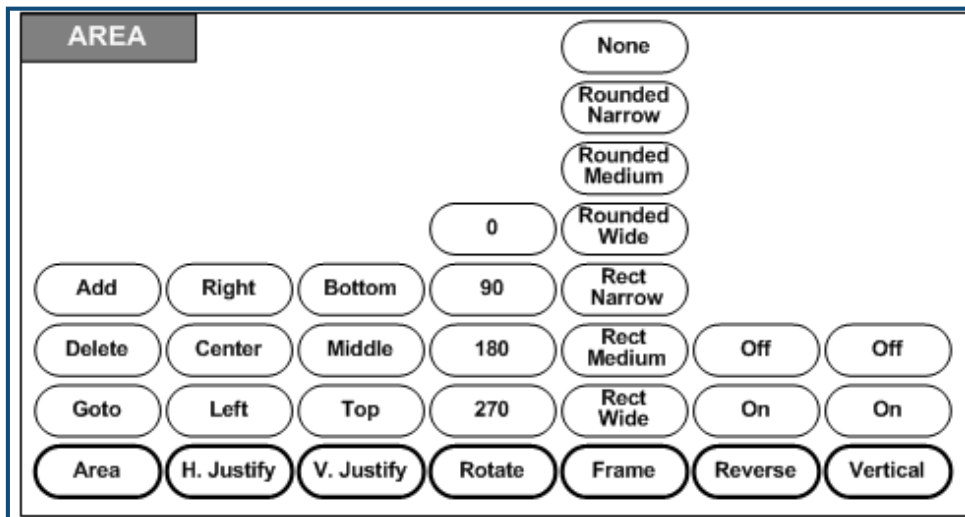

Figure 18 • Area menu options

Areas are used to apply different formatting (such as justification, rotation, and frames) to different parts of a single label. Areas can only be added to continuous media set to auto length mode. However, area *formatting* can be applied to die cut labels that have pre-defined areas.

Only the current area displays on the editing screen. Use Print Preview (see [page 80](#)) to view the label with all its areas.

Fixed Length

If using continuous media, the label length will be as long as necessary to accommodate the font size and attributes applied to the label. However, you can set the length of the media to a fixed length. To set a fixed length for continuous media:

1. Press Label Settings **SETTINGS SERIAL**.
2. Navigate to **Length>Fixed**.
3. Enter the desired fixed length in the pop-up field.
4. Press Enter .

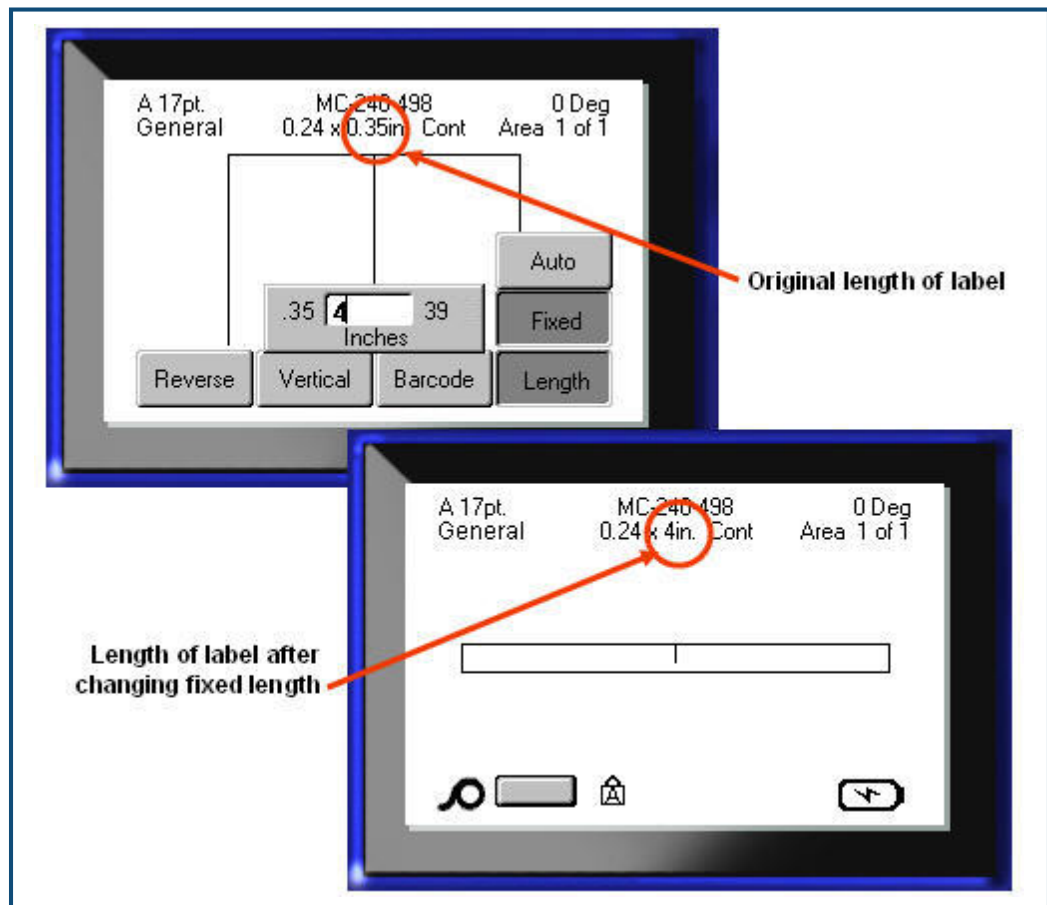



Figure 19 • Adding a fixed length

Add Areas



To add an area to a label:

1. Press Area  .
2. Choose **Add**.
3. Press Enter  .

A new area is added at the end of existing areas and is reflected on the upper right side of the display screen. The font size used on the first line of the previous area carries over to the new area.

Go To An Area

To move to another area on a multi-area label:

1. Press Area  .
2. Choose **GoTo**, then enter the number of the label or area to go to.
3. Press Enter  .

Shortcut

To go to the next area on a multi-area label:

1. Press Next Area  +  .

To go to the previous area on a multi-area label:

2. Press Previous Area  +  .

Delete Area

To delete an area:

1. Navigate to the area you want to delete.
2. Press Area .
3. Choose **Delete**.

A delete confirmation message displays.



To delete the area:

4. Press Enter .

To cancel the delete function, thereby not removing the specific area from the label:

5. Press Backspace .

Justification

Justification refers to the alignment of data between boundaries on a label or in an area. There are two types of justification: horizontal and vertical. Horizontal justification (H. Justify) aligns data between the left and right boundaries of a label or area, while Vertical justification (V. Justify) aligns data between the top and bottom boundaries of a label or area. Justification is applied to an area or a label. It cannot be applied line-by-line.

To apply justification:

1. Navigate to the label or area where justification is to be applied.

2. To apply justification to a label, press Label Settings .

OR

To apply justification to an area, press Area .

3. Choose **H. Justify** or **V. Justify**.

4. Choose the horizontal or vertical justification desired.

5. Press Enter .

Every line of data on the label or in an area is justified according to the option selected. Different justification can be applied to different areas on one label.

Rotate

Rotation flips the data on a label, counter-clockwise, at 90° increments. Rotation affects all data on a label.



123	123	123	123
0°	90°	180°	270°

Figure 20 • Degrees of rotation on printed label

Note: If rotation is applied individually to areas, you cannot apply rotation to the entire label.

Data cannot be rotated on a line-by-line basis. When adding a new area, the rotation is the same as the previous area.

To rotate data:

1. Navigate to the label or area where rotation will take affect.
2. To set rotation for the label, press Label Settings  .
OR
To set rotation for an area, press Area  .
3. Choose **Rotate**>*degree of rotation*.
4. Press Enter  .

Note: If the auto font size is selected, rotated data is autosized to accommodate the height vs. the width of the label. However, if using a fixed font size, the rotated data may not fit on the label. If this occurs, an error message displays indicating rotated text will not fit. The Rotate function is canceled and data is not rotated.



To clear the error message:

1. Press Backspace  CLEAR

The Rotate function is canceled and data is not rotated.

Frame

A frame (border) can be added to an area or a label, but not to a line of text. You can have a different frame, or no frame, on individual areas in a multi-area label. You can also place a frame on a label that contains area frames.

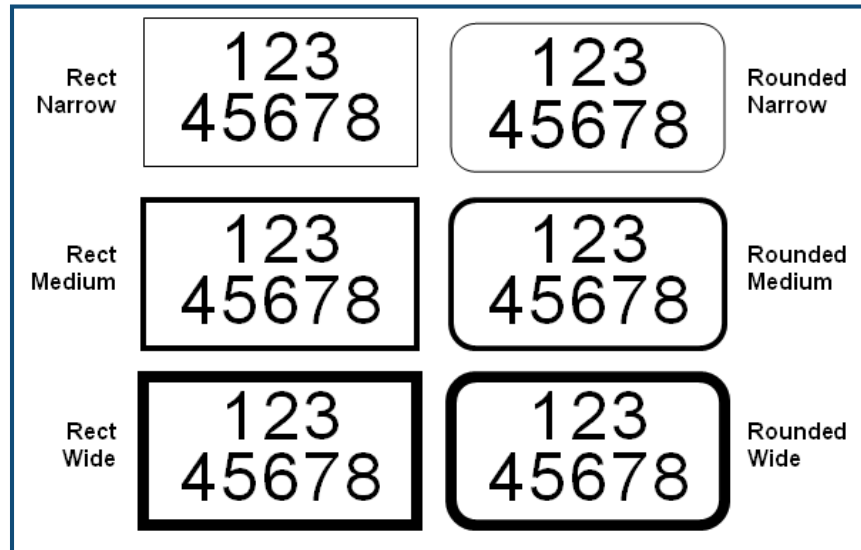



Figure 21 • Available frame options

1. To add a frame to a label, press Label Settings .

OR

- To add a frame to an area, press Area .

2. Choose **Frame**>*frame type*.

3. Press Enter .

Frames do not display on the editing screen. Use Print Preview (see [page 80](#)) to view the label or area frames.

To remove the Frame:

1. Navigate to the label or area that contains the Frame.

2. Press Label Settings .

OR

- Press Area .

3. Chooses **Frame**>**None**.

4. Press Enter .

Reverse

The Reverse function switches the foreground and background colors of data on a label, based on the media installed.





Figure 22 • Reverse text

For instance, black lettering on a yellow background, if reversed, would print yellow lettering on a black background.



You can apply Reverse formatting to areas or labels. Reverse cannot be applied to an individual line of text or to a barcode.

To apply Reverse formatting to a label or area:

1. Press Label Settings  .
OR
Press Area  .
2. Choose **Reverse>ON**.
3. Press Enter  .

The system formats the edge-to-edge data so that the foreground and background colors are switched.

To remove the Reverse function:

1. Navigate to the label or area displayed in Reverse.
2. Press Label Settings  .
OR
Press Area  .
3. Choose **Reverse>OFF**.
4. Press Enter  .

Vertical Text

In Vertical text, each character drops down a line below the preceding character.

Example: The word “WIRE” as vertical text displays as such:

W
I
R
E

Vertical text can only be applied to an area or a label. It cannot be applied line-by-line.

To format text vertically:

1. Navigate to the label or area where you want to display text vertically.

2. Press Label Settings .

OR

Press Area .

3. Choose **Vertical>On**.

4. Press Enter .

The word(s) display vertically on the label or in the area.

If more than one line of text is present, the second and subsequent lines of text display vertically to the right of the first line of text.

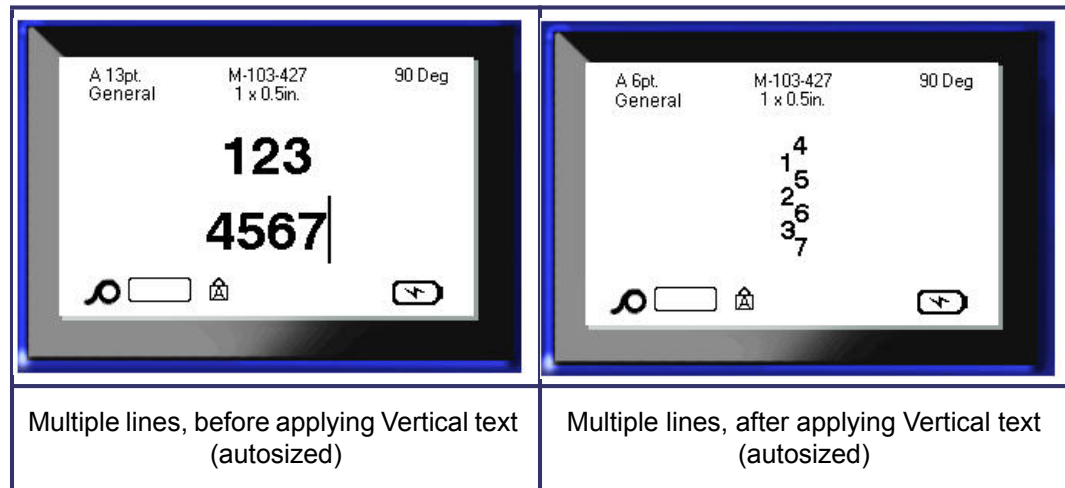

Figure 23 • Multi-line vertical alignment

If a barcode is in the line of text to be placed vertically, or if the height of the label cannot accommodate the vertical placement of text, an error message displays.

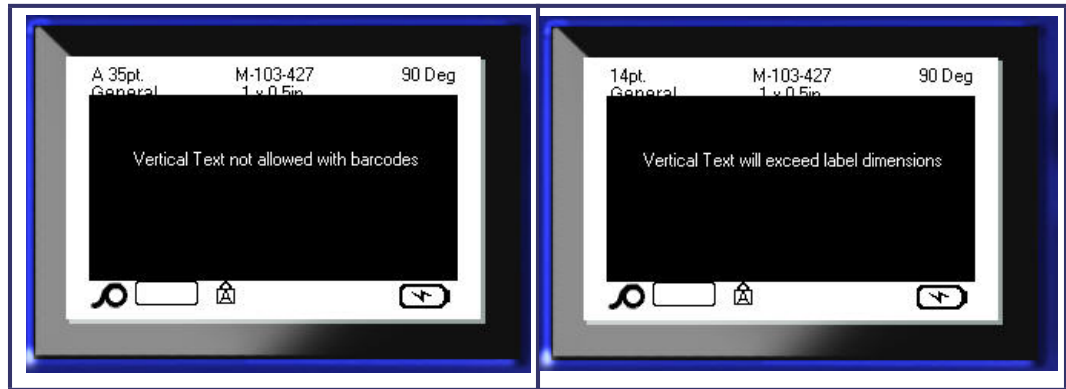





Figure 24 • Error messages when applying Vertical text

After removing the error message, the text is displayed in its original format, without applying the vertical text option.

1. Navigate to the label or area displaying data as Vertical Text.
2. Press Label Settings  .
OR
Press Area  .
3. Choose **Vertical>OFF**.
4. Press Enter  .

The text realigns according to predefined formats.



Barcode

Barcode data can be displayed in the same line as other data (text or symbols). It is not necessary to have a separate area for the barcode. Barcode data on the same line as text will not overwrite the text already on the line but will be placed next to it.

Barcode Settings

Field	To Use
Barcode Symbology	The BMP [®] 41 Label Printer supports Code 128 and Code 39 barcode symbology.
Ratio	The ratios available are 2:1 and 3:1.
Height	The height of the bars in a barcode can vary, with a minimum of 0.1 inch (2.54 mm) and a maximum of 1.2 inches (30.48 mm).
Width	The width of the narrow bar of a barcode is 1, 2, or 3 dots.
Human Readable	Human Readable text can be placed above or below the barcode, or you can choose not to display it.
Check Digit	A check digit is used for error detection when using a Code 39 barcode. You can turn the check digit function on or off.

To change any of the barcode settings:

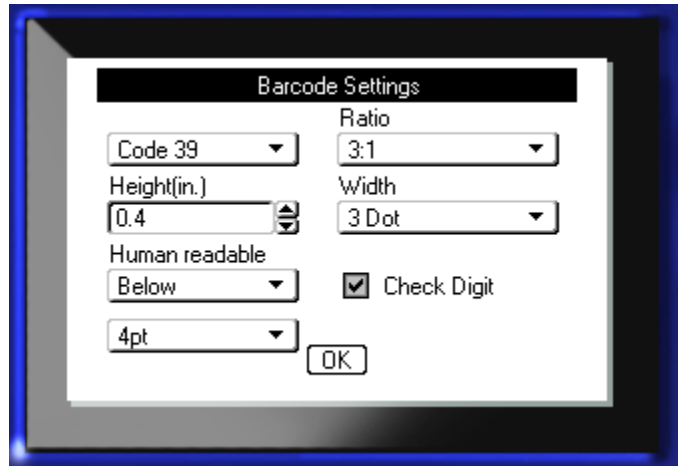

1. Press Label Settings .
2. Navigate to Barcode main menu.
3. Press Enter .

A dialog box displays.



4. Use navigation keys to access the various fields that you want to change. (See [page 23](#) for more information on working with dialog boxes.)

When finished, to accept all changes:

5. Navigate to  and press .
6. Press Backspace  to exit out of the Label Settings menus.

Add a Barcode

The barcode key acts as a toggle between a barcode and text. Press once to turn it on, press again to turn it off.

To add a barcode:

1. Position the cursor where you want to add the barcode.
2. Press Barcode .

The barcode displays start and stop characters following the barcode parameters determined in the Barcode main menu under Label Settings function.

3. Enter the barcode data.

The barcode displays on the screen as the data is being entered. If the Human Readable option has been turned off (i.e., “None” is selected), a data entry box displays directly over the barcode, enabling you to view and edit the barcode data as you enter it. The data in this entry box does not print out. If you want the actual data that the barcode represents to print out, select Below or Above in the Human Readable field of the Barcode main menu.

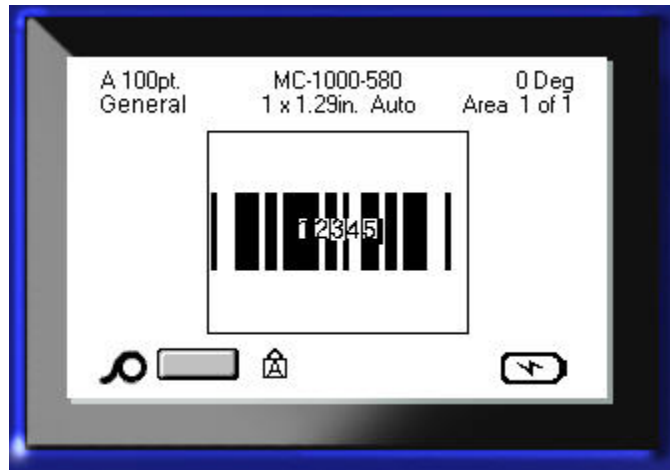

Figure 25 • Barcode non-printable text box when HR option turned off

When finished with the barcode entry, if you want to enter more data on the same line of text as the barcode:

4. Press Barcode  again.

This turns the Barcode mode off and returns to text mode.

OR

When finished with the barcode entry, if you want to start a new line of text BELOW the barcode entry:

5. Press Enter .

Pressing OK moves the cursor to the next line, automatically turning off the Barcode function.

Edit Barcode Data

To edit barcode data:

1. Position the cursor in the barcode text.

The barcode mode automatically turns on.

2. Edit the barcode text.

The barcode mode automatically turns off when you move past the last character of the barcode.

Serialization

Serialization (or sequencing) automatically adds a series of sequential numbers or letters to the printed labels. The Serial function consecutively places the next number or letter in the defined sequence on individual labels. The number of labels created is defined by the sequence values you enter. You can view the serialized labels before they print through the Print Preview function. (See “Print Preview” on *page 80* for more information.)

Serialization can be combined with other data on a label. Any data displayed on a label that includes serialization will be repeated on every label along with the serial data.

How Serialization Works

Serialization is alphanumeric, with numbers from 0 to 9, and letters A-Z. Serialization can be simple or linked, with a maximum of two sequences per label.

Note: You can incorporate serialized data into a barcode.

Serialization consists of a Start Value, End Value, and Increment. The Start Value is the number, letter, or combination of numbers and letters that begin the serialization sequence. The End Value is the termination point of the sequence.

The Increment is the value that is added to the previous number in the sequence to produce the next sequence number. (You cannot have an increment value of 0.) For instance, a start value of 1, an end value of 25, and an increment of 4 would produce 1, 5, 9, 13, 17, 21, 25.

Examples of Serialization

In a simple serialization, a sequence runs through its full range of numbers and/or letters (i.e., 0 to 9, or A to Z), one number/letter for each label.

Example: Simple serialization:
Sequence #1
Start Value: 1
End Value: 10
Increment: 1
Produces: 1, 2, 3, 4, 5, 6, 7, 8, 9, 10

You can combine letters and numbers in a single serialization. When the right-most character in the Start Value reaches its maximum value (9, Z), the character immediately to the left is incremented, and the right character cycles back to its minimum value (0, A)

Example: Combined, single serialization:
Sequence #1
Start Value: A1
End Value: D4
Increment: 1
Produces: A1...A9, B0...B9, C0...C9, D0...D4

In a multi-sequence serialization, where the second set of values is NOT dependent on the first set (i.e., Linked box NOT checked), the two sequences increment sequentially, independent of each other.

Example: Multiple serializations (where the second set of values is NOT dependent on the first set of values):

Sequence #1	Sequence #2
Start Value: 1	Start Value: A
End Value: 10	End Value: C
Increment: 1	Increment: 1
Produces: 1A, 2B, 3C, 4A, 5B, 6C, 7A, 8B, 9C, 10A	

In a multi-sequence “linked” serialization (i.e., Linked box checked), the second set of values is dependent on the first set. The second sequence holds its initial value until the first sequence completes, after which it moves to the next value.

Multiple linked serialization:

Sequence #1	Sequence #2
Start Value: 1	Start Value: A
End Value: 10	End Value: C
Increment: 1	Increment: 1
Produces: 1A..10A, 1B..10B, 1C..10C	

Numbers in Sequences

Single digit numbers are “padded” with zeros (0), which you can display if desired. To display zeros, enter a zero before single-digit numbers (e.g., 01, 02, 03...). If the 0 is not entered, it becomes a virtual 0 acting as a placeholder, allowing for better alignment of numbers/letters.

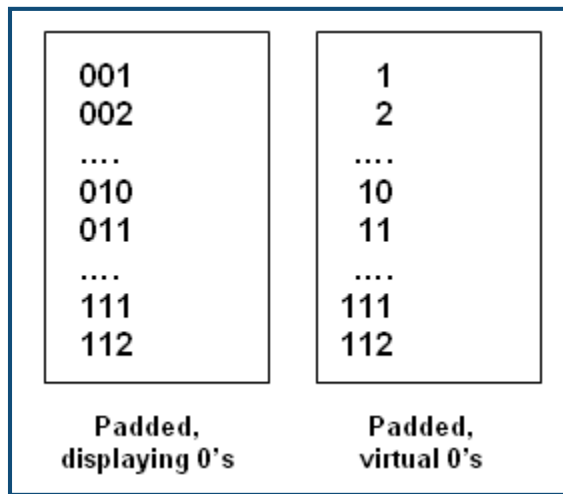

Figure 26 • Displayed vs. virtual zeros in sequences

Add Serialization

To add serialization to labels:

1. Position the cursor on the label where you want the serialization to display.
2. Press Serial **FN** + **SETTINGS SERIAL**.

A dialog box displays where you can enter the start value of the serialization, the end value, and the increment value.

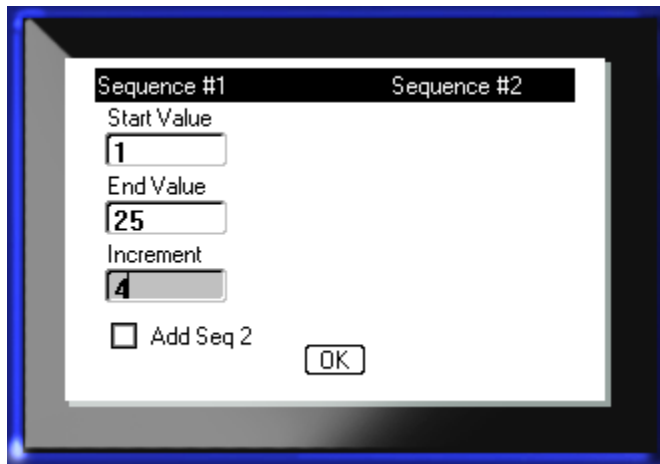

For simple serialization:

3. With the cursor immediately displayed in the *Start Value* field of Sequence #1, enter the start value of the sequence.

If the start value is larger than the end value, the series will decrement automatically.

4. In the End Value field, enter the end value of the sequence.
5. In the Increment field, enter the increment value.

The default increment is 1. If that is the desired increment, skip this entry field.

6. Navigate to **OK** and press Enter .

For multiple serialization:

7. Complete Steps 1 through 6 above.
8. On the Editing screen, navigate to the next sequence location (cursor position) on the label.

Note: If creating a compound serialization to display at the same cursor position on the label, complete Steps 1-5 above, then proceed immediately to Step 10 below.

9. Press Serial **FN** + **SETTINGS SERIAL**.

The previous serialization values display in the dialog box presented.

10. Navigate to the Add Seq 2 option box and press Enter .

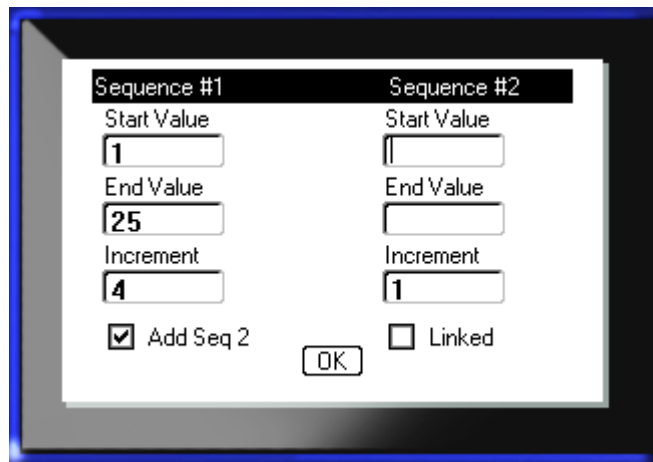



A second set of sequence value fields is presented.

11. In the Sequence #2 Start Value field, enter the start value for that sequence.
12. In the Sequence #2 End Value field, enter the end value for that sequence.
13. In the Sequence #2 Increment field, enter the increment for that sequence.

For Linked serialization:

Note: Linked serializations do not have to display at the same position on the label. They can be in separate locations within the label.

14. Navigate to the Linked option box and press Enter .

15. When finished, navigate to and press Enter .

Edit a Sequence

You can change the serialization values after a sequence has been determined. To edit the sequence values:

1. Press Serial  + .

The Serial dialog box displays with the current values listed.

2. Navigate to the value fields to change and enter the new value.
3. Navigate to and press Enter .

File Management

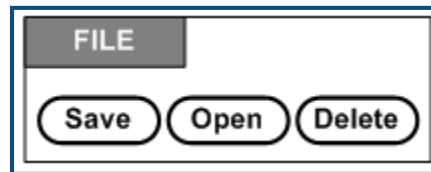

Figure 27 • File menu options

A label can be saved as a file, to be opened and reused at a later date.

File Naming Standards

To create a file on the BMP[®]41 Label Printer, the file must be given a name. Names can be up to 20 characters long and can consist of letters, numbers, and spaces.

When creating files, remember this rule: You cannot have two files with the same name. If you do, the most recent file with the name will overwrite the previous file with that name. A one-character difference in the name creates a different file and will not overwrite a previous file.

Save

You can save a file internally on the BMP[®]41 Label Printer or on some external device (such as a thumb drive). The saved file retains the label data, data attributes, and alignment parameters. This file is available for reuse whenever needed.

To save labels as a file:

1. Press File **FN** + LABEL TYPE **FILE**.
2. Choose **Save**, then press Enter .

To save internally (on the BMP[®]41 Label Printer), proceed to Step 9.

If storing externally, ensure the thumb drive is plugged into the appropriate port. The presence of the external drive will bring up the following screen.

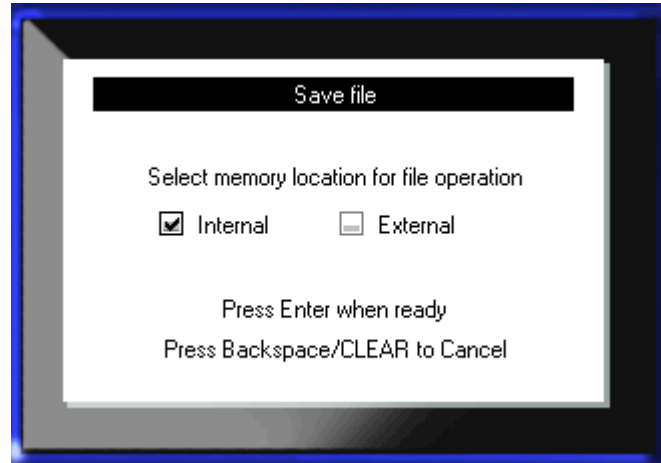

To save externally (on a thumb drive):

3. Navigate to the External option box.

4. Press Enter .

To save your file, proceed to Step 9.



To create a directory system for ease of locating files, place the files into folders. To create a folder:

5. Navigate to **<New Folder>** and press Enter .

6. Enter a name for the folder in the field provided, and press Enter .



The folder is automatically opened. To save a file in this open folder, proceed to Step 9. To save the label file in a different folder from the one that is open:

7. Navigate to  **Previous folder** and press Enter .

8. Navigate to the desired folder and press Enter .

9. In the **<New File>** entry box, enter a name for the label file and press Enter .



If the name already exists, a message displays asking if you want to overwrite the previous file with that name.



10. To overwrite, press Enter .

OR, to remove the message from the screen and return to the file name entry box:

Press Backspace  CLEAR.

11. To enter a different file name repeat Step 9.

Remove File from Screen

When the file is saved, you are returned to the Editing screen with the saved file still displayed.

To remove the saved file from the screen:

1. Press Clear  + .
2. Choose  and press Enter .

A message displays confirming the removal of all labels from the display.



3. Press Enter  to delete the label from the display.

OR, to remove the error message and cancel the Clear All function:

Press Backspace .

Open a File



To open (recall) a saved file:

1. Press File **FN** + **LABEL TYPE FILE**.
2. Choose **Open** and press Enter .
3. Indicate if the file to open is stored internally on the BMP®41 Label Printer, or externally on a thumb drive.

Note: If the file to be opened is stored externally, in order to get the desired list of files, be sure to plug the thumb drive into the appropriate port.

4. Press Enter .

A list of previously saved files and folders displays. If the file is stored in a folder:

5. Navigate to the desired folder to open and press Enter .
6. Then, navigate to the desired file to open and press Enter .

Only one file can be displayed on the screen at a time. When opening a saved file, if the Editing screen contains other data, you are prompted to save the data before the screen is cleared. If you decide to save the displayed data, the Save function is invoked and you are allowed to give the data a file name before the requested file to open is displayed in the Editor.

When opening a file, if the stored data does not fit on the installed media, an error message displays.





You must use label media that can accommodate the data in the file being opened. You cannot place data saved with die-cut media on continuous media, and vice versa.

7. Press Enter  to remove the error message and install the correct media to accommodate the data.

Delete a File

The display screen does not have to be cleared before deleting a file. A file can be deleted with other data still on the screen.

To delete a previously saved file:

1. Press File  + LABEL TYPE .
2. Choose **Delete** and press Enter .
3. In the dialog box presented, use navigation keys to move to the option box indicating if the file to be deleted is stored internally on the BMP[®]41 Label Printer, or externally on a thumb drive, PC, etc.

Note: If the file to be deleted is stored externally, be sure to connect to the external source in order to get the desired list of files.

4. Press Enter .

A list of previously saved files displays.

5. Using navigation keys, choose the file to delete.
6. Press Enter .

A delete confirmation message displays.



7. Press Enter  to accept the deletion.

OR, to cancel the delete function:

Press Backspace  CLEAR .

When a file is deleted, it is removed from the system and is no longer available for use.

This page intentionally left blank.

Printing

The Print function prints the current file.

To print:

1. Press Print



The data is printed.

After printing, to cut the label:

2. Push the cutter lever down as far as it will go.

Rollers on the label exit chute hold the label in place after it has been cut to avoid dropping. To remove the label:

3. Gently pull the label from the rollers.

Printing from the BMP[®]41 Label Printer occurs in the background, meaning you can continue to edit or create new labels while the file is printing.

Cancel a Print Job

If a print job is interrupted, for instance when media runs out, or you intentionally open the cover, the system automatically stops the print job and displays a message. While the message remains on the screen, follow the instructions on the display to resume printing.

To intentionally cancel a print job:

1. Press Shift+FN+Print



Print Preview

The Print Preview function of the BMP[®]41 Label Printer enables you to view your label file prior to printing.

To preview the label:

1. Press Print Preview  .

The label contents display as they will print out.

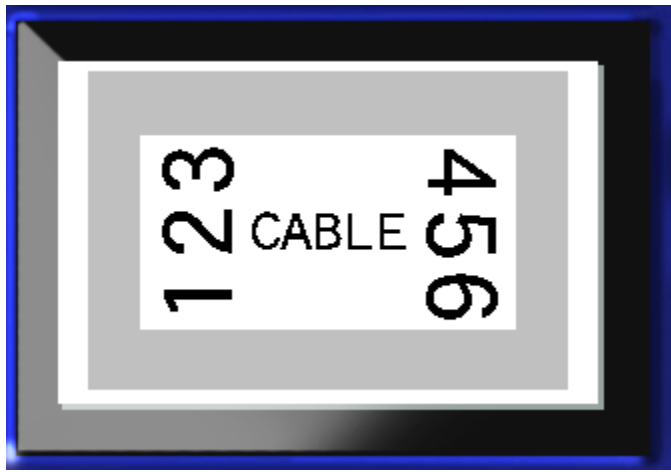

To exit Print Preview and return to the editing screen:

1. Press Backspace  .

You are returned to the editing screen.

Scrolling in Print Preview

If a label file is particularly long it may not be completely visible on one screen in print preview. The Print Preview screen displays a scroll bar indicating there is more data to view.

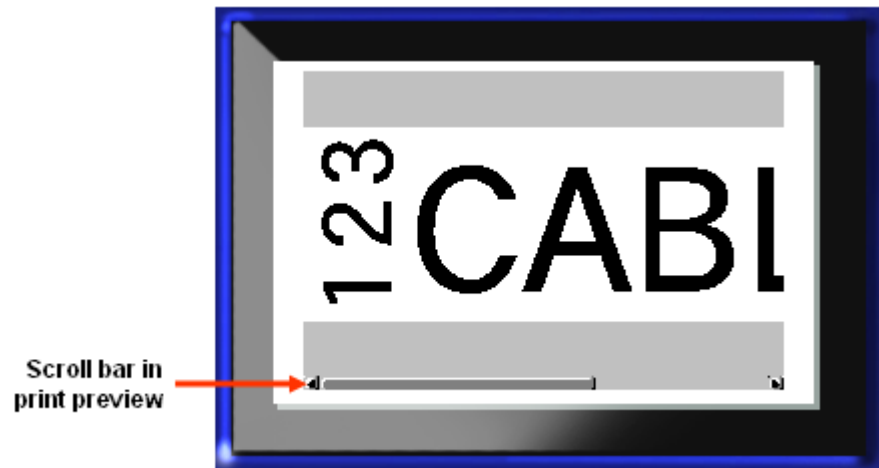

To scroll through a preview of a long label:

1. Press Left/Right navigation keys, as applicable.

Scrolling in Multi-Area Preview

When using serialization, multiple areas are created. To scroll through the different labels in print preview:

1. Press Up/Down navigation keys, as applicable.

Multi-Print

Pressing the Multi-Print key brings up a dialog box displaying the following options:

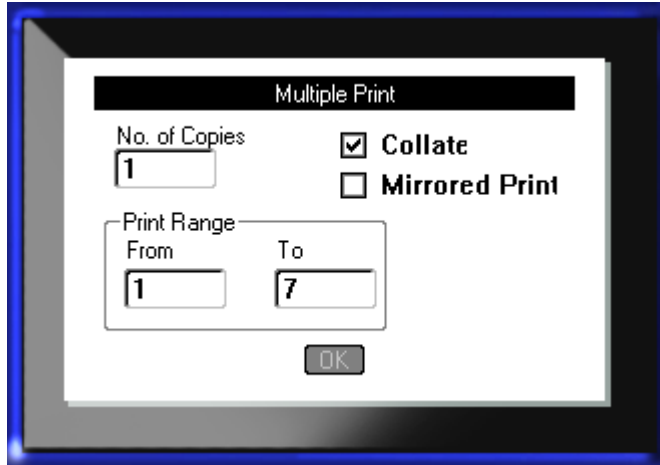

Multi-print lets you print a number of copies of a label or a range of labels in a multi-label (series) file. If printing a number of copies, you can also determine if you want the copies collated or not.

Note: Depending on the media and label type in use, the Multi-print dialog box may display the option to define a separator (tic or line). See Figure 35 on [page 91](#) for a description of tic and line separators.

Collate

Collating refers to the way a series of labels print out, if more than one copy or set of labels is requested.

Collated – All sequential numbers print once, then the entire sequence prints again.

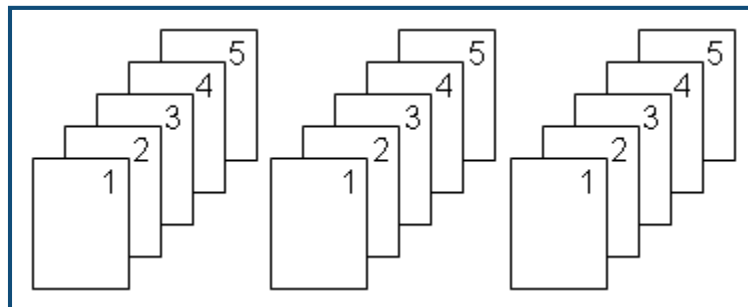

Figure 28 • Three copies of five labels, collated

Non-collated – Prints all first numbers in a sequence, then all second numbers, etc.

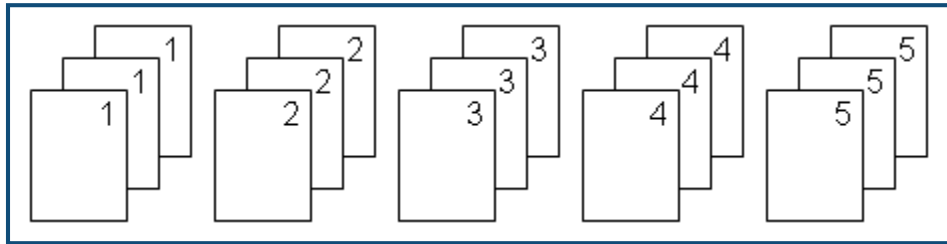



Figure 29 • Three copies of five labels, non-collated

To print a number of copies:

1. Press Multi-Print  + .

2. With the cursor in the *No. of Copies* field, enter the number of copies desired.

Determine if the copies should be collated. The default is to print collated. If you do not want to collate the copies:

3. Navigate to the Collate option box and press Enter  to remove the checkmark.

When printing (or re-printing) a single label in a series, or a range of labels in a series, use the Print Range feature.

4. Navigate to the *From* field, under Print Range, and enter the number of the first label to be printed.
5. Navigate to the *To* field, under Print Range, and enter the number of the last label to be printed.

Mirror Print

Mirrored print takes all data on a label and flips it to provide a mirror image. Mirroring displays on the printed label only.

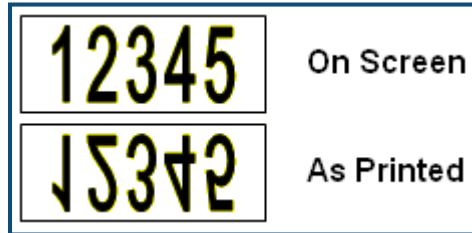



Figure 30 • Mirror image

Mirrored print is label-based, meaning all data on the label is mirrored. You cannot mirror data in an individual area.

To provide a mirror image of label contents, in the Multi-Print dialog box:

1. Navigate to the *Mirrored Print* option box and press Enter  to place a checkmark in the field.
2. When finished with desired options, navigate to and press Enter .

Label Types

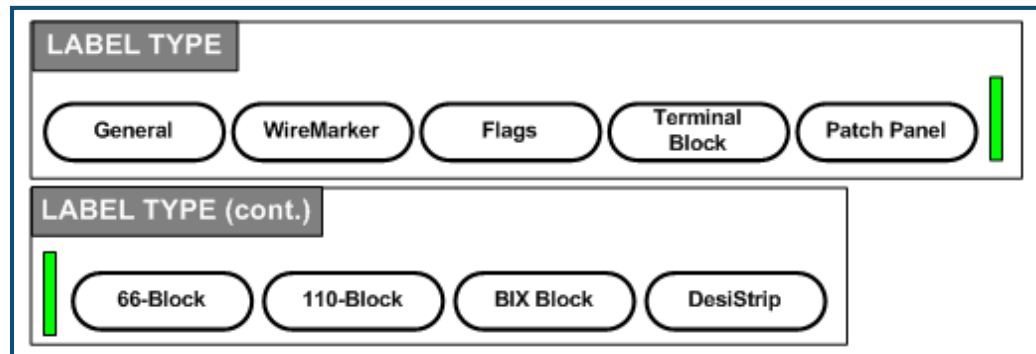



Figure 31 • Label Type menu options

The general editing mode of the BMP[®]41 Label Printer contains standard functions and formats used for most generic labels. Label types, however, provide templates that guide and control the layout for specific label formats.

Accessing a Label Type

To work with a label type:

1. Press Label Type .
2. Choose the desired Label Type.
3. Press Enter .

For most label types, a dialog box displays to collect information for automatically formatting the specific label type.

4. Enter data requested in the dialog box.
5. When finished, navigate to and press Enter .

The label type's template is launched. The name of the specific type being used is displayed on the left side of the Status bar, below the font size.

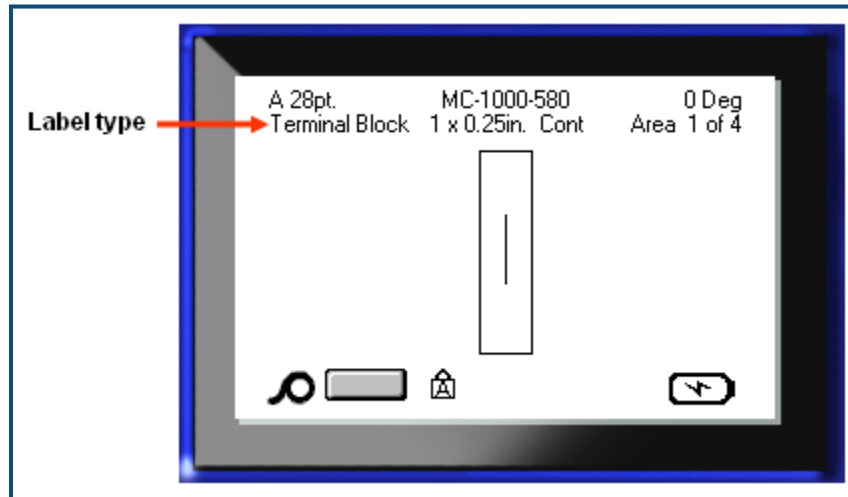



Figure 32 • Display of label type in status bar

General Label Type

When you are using a specific label type, clearing the data removes the data you entered but the specific label type parameters remain. To exit out of the specific label type and return to the general editing mode of the BMP[®]41 Label Printer, select the General label type:

1. Press Label Type  .
2. Choose **General**.
3. Press Enter  .

The previous label type in use is removed from the screen and you are returned to the general editing mode.

WireMarker

The WireMarker label type is designed to repeat entered text down the length of the label. The data will repeat as many times as possible, considering the font size and the number of text lines available on the label.

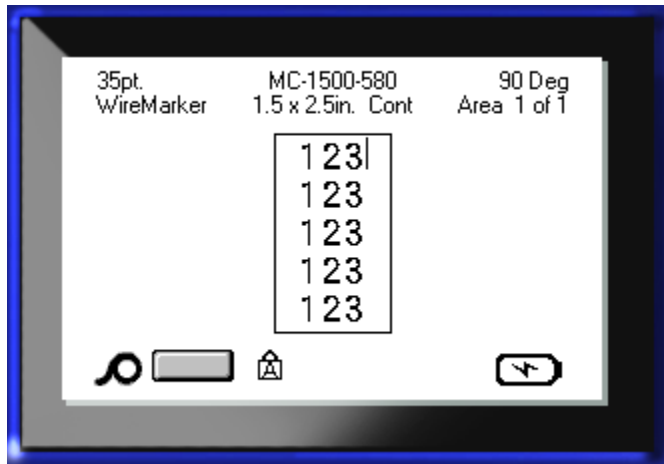



Figure 33 • Repeated data on a WireMarker label

Die-cut, self-laminating, or continuous media can be used for WireMarker labels.

To use the WireMarker label type:

1. Press Label Type .
2. For continuous media, choose **WireMarker**>*wiremarker size*.
OR
For die cut media, choose **WireMarker**
3. Press Enter .
4. Enter the wiremarker data.

As you enter data, the data is repeated down the label. The font size is set to Auto, but can be changed as desired. (See [page 40](#) for information on changing font size.)

If you press [Enter] to start a new line of text, a space opens below each line of repeated data and begins to repeat the next line of text as you enter it.

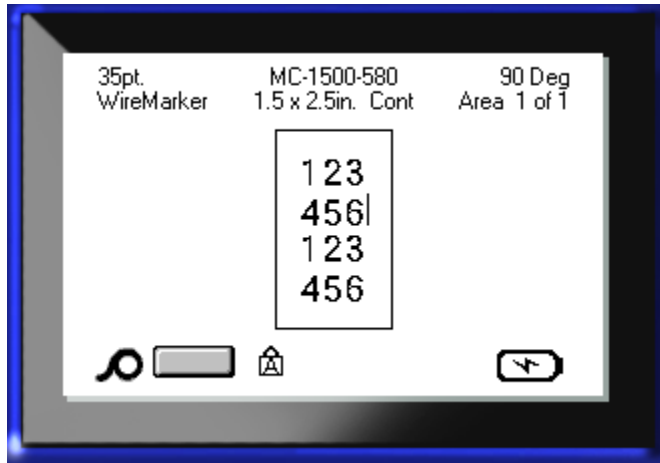

Figure 34 • WireMarker label with multiple lines

Terminal Block, Patch Panel, 66 Block

Terminal Block, Patch Panel, and 66 Block label types are designed to be used with continuous media. If continuous media is not installed, these label types do not display in the menu.

To use Terminal Block, Patch Panel, or 66 Block label type:

1. Press Label Type **LABEL TYPE FILE**.
2. Navigate to the desired label type and press Enter .

A dialog box displays requesting additional information. (For a review of dialog box navigation, see [page 23](#).)

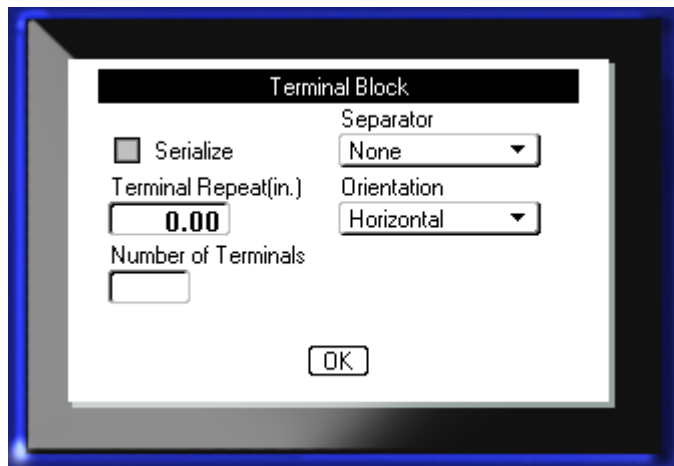

If you DO NOT intend to serialize terminal block labels, proceed to Step 4.

3. Navigate to the Serialize option box and press Enter  to select the option. (You are on the Serialize option upon entering the dialog box.)

4. Navigate to the *Separator* field and, from the drop down list, select the separator to use.
5. Navigate to the *Orientation* field and, from the drop down list, select the desired layout.

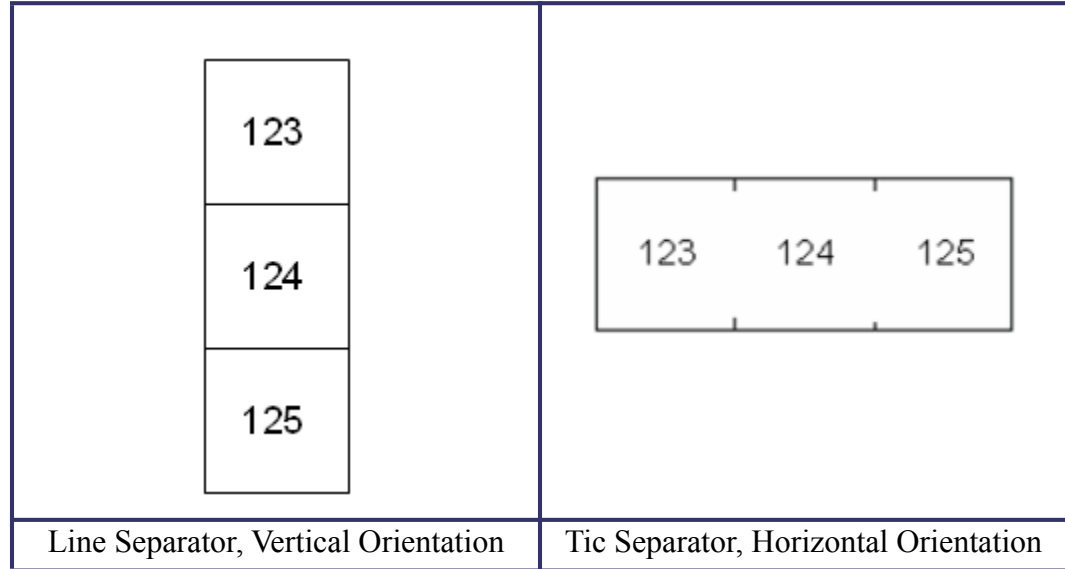



Figure 35 • Separators and Orientation

6. Navigate to the *Terminal Repeat* field and indicate the size of the gap between each terminal (with a minimum of 0.2 inches).

If you are serializing the Terminal Block label type, you do not need to enter the Number of Terminals. The serialization values determine how many labels to create. Proceed to Step 8.

7. In the *Number of Terminals* field, enter the number of terminals on the block for which the label is intended.

8. When finished, navigate to and press Enter .

If the Serialize option box is checked, the Serial dialog box displays.

9. Complete the Serialization values. (See “Add Serialization” on [page 66](#) for more information.)

10. When finished, navigate to and press Enter .

The number of terminal blocks are created as areas on one label, with the serialization characters displayed in each area. If serialization was not used, on the Editing screen, enter unique data for each label, using Next Area or Prev Area to move to the different areas.

Use Print Preview to view the multi-area label before printing. (See [page 80](#) for information on navigating multi-area labels in Print Preview.)

Flags

A Flag label wraps around a wire or cable, with the ends joined together to form a flag. The Flag label type is designed to work with continuous media or specific multi-area die cut labels.

To use a Flag label type:

1. Press Label Type **LABEL TYPE FILE**.

2. Choose **Flags** and press Enter .

A dialog box displays the different Flag layouts, preceded by a radio button.

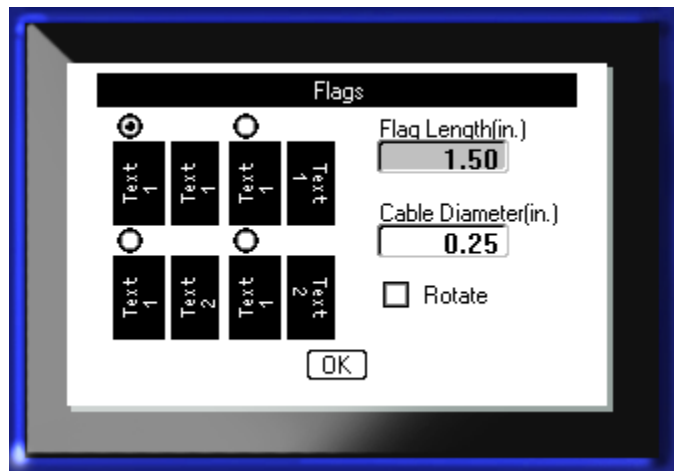

To select a layout:

3. Navigate to the radio button of the desired layout and press Enter .

4. If continuous media is installed, navigate to the *Flag Length* field and enter the length of the flag (the part that contains the text).

5. Navigate to the *Cable Diameter* field and enter the diameter of the wire/cable to which the flag will be applied.

The range for the cable diameter is 0.25 inches to 8 inches. By entering the diameter of the wire or cable, the system automatically calculates an additional length of label to allow complete wrap of the wire/cable with additional label material left for the flag.

Note: If using pre-defined die-cut media, the Flag Length and Cable Diameter fields will be grayed out and not available for input.

- When finished, navigate to and press Enter .

Rotation is embedded in the template design, based on the flag design you pick. Justification is defaulted to center, middle, and autosize is automatically turned on.

If the design chosen indicates only one text element, the printer automatically duplicates the entered text for the other area, rotating according to the predefined layout.

In a 2-text element flag layout, you enter text in two separate areas. Use the [Alt + Next Area/Prev Area] keys to move to the different areas. The status bar indicates which area you are in.

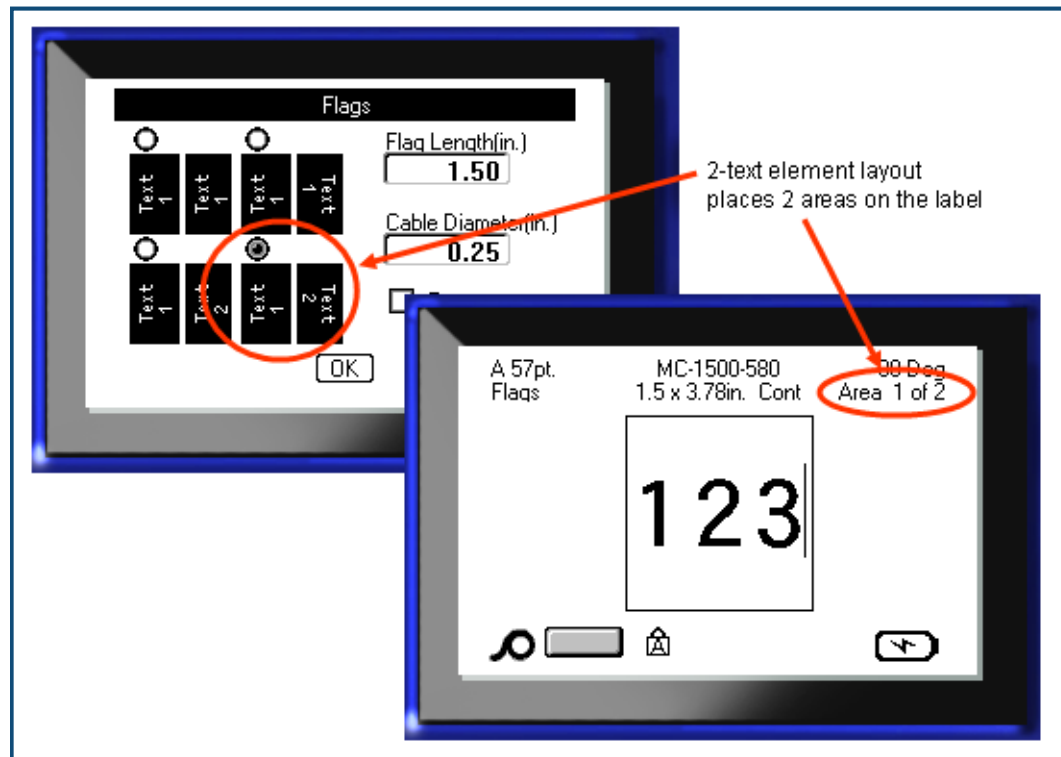

Figure 36 • Number of areas based on Flag configuration

110-Block, Bix Block Label Type

The 110-Block and Bix Block use only the following dedicated label parts.

- 110-Block: MC-475-412 or MC-412-422
- Bix Block: MC-625-412 or MC-625-422

The 110-Block label type is based on user-selected pair configurations, with the length of the label determined by the pair type selected. The label height uses a dedicated 110-Block part height of 0.475 inch. The length of a 110-Block label is 7.5 inches, with a total strip length of 7.9 inches. The number and formatting of areas is based on pair configuration and serialization selected.

Bix Block template information is similar to the 110-block, with some variations on height and length of strip. The label height uses a dedicated Bix Block part height of 0.625 inch. The length of a Bix Block label is 6.2 inches with a total strip length of 6.6 inches.

To use the 110- or Bix Block application:

1. Press Label Type **LABEL TYPE FILE**.
2. Navigate to 110-Block or Bix block and press Enter .

A dialog box displays requesting further information. (For a review of dialog box navigation, see [page 23](#).)

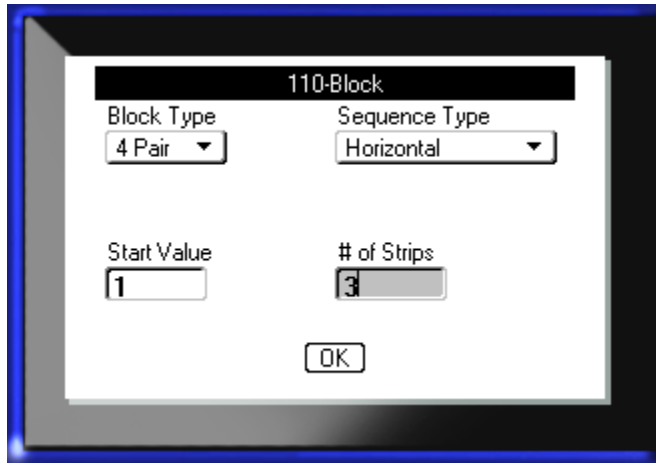

In the 110- and Bix Block applications, the number of areas created is based on the pair configuration selected.

- 2 pair = 24 areas
- 3 pair = 16 areas
- 4 pair = 12 areas
- 5 pair = 10 areas
- Blank = 2 areas

Vertical and horizontal separator lines are automatically added.

The following example displays the areas based on the Block Type selected (i.e., 2-pair, 3-pair, 4-pair, 5-pair, or blank). The “Blank” strip is formatted as two areas covering the full printable length of the strip.

2 pair													
	1	2	3	4	5	6	7	8	9	10	11	12	
	13	14	15	16	17	18	19	20	21	22	23	24	
Blank													
	Text entered in area 1 prints here												
	Text entered in area 2 prints here												

Figure 37 • Sample pair configurations

3. In the *Block Type* field, from the drop down list, choose the pair configuration to use.

Sequence Type is used to determine how, and if, you want to serialize data. If None is selected, the areas are blank and you can independently enter data in each area of the strip. Horizontal increments one number per area, based on the start value.

In Backbone serialization, the left-most area on each strip prints with two numbers. The first number is left-justified; the second number is right justified. All other areas print with one right-justified number.

2 pair - none												
2 pair - horizontal												
1	2	3	4	5	6	7	8	9	10	11	12	
13	14	15	16	17	18	19	20	21	22	23	24	
2 pair - backbone												
1	2	4	6	8	10	12	14	16	18	20	22	24
25	26	28	30	32	34	36	38	40	42	44	46	48

Figure 38 • Sample sequence types

4. In the *Sequence Type* field, from the drop down list, select the Sequence Type to use.
5. In the *Start Value* field (except when “None” is selected in the *Sequence Type* field), enter the first number of the sequence.
6. In the *# of Strips* field, enter the number of strips (labels) to be created in the block configuration chosen.

Note: If serializing the data, additional strips will continue the serialization from the last number of the previous strip. For instance, when requesting two strips of a 4-pair configuration, the first strip will contain values 1-12, the second strip will contain numbers 13-24.

7. When finished, navigate to and press Enter .

DesiStrip

To create a DesiStrip:

1. Press Label Type **LABEL TYPE FILE**.

2. Navigate to DesiStrip and press Enter .

The default length is 1.5 in. To enter a different length:

3. In the Length field, press Backspace  **CLEAR** to clear the default length.

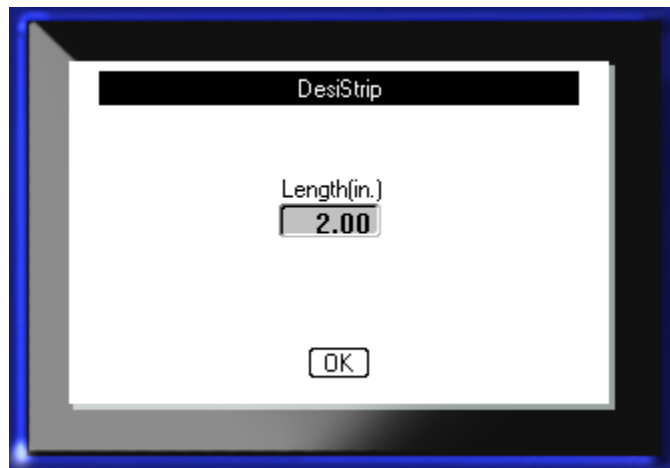

4. Enter the new length of the individual strip.

5. Navigate to **OK** and press Enter .

This page intentionally left blank.

Troubleshooting

Use the following table to troubleshoot and diagnose possible performance problems with your BMP®41 Label Printer. If the corrective action suggested does not work, contact Brady’s Technical Support Group at www.bradyid.com.

Problem	Cause	Corrective Action
Hardware		
Head over temp	Print Head too hot	Print head has reached maximum operating temperature. Let print head cool down for approximately 10 minutes, then re-initiate print job.
Keyboard works intermittently or not at all.	One or more keys is stuck in depressed state.	Identify any keys stuck in down position. Repress key to un-stick.
Error - “Locking lever not closed Close lever.”	Locking lever not in locked position.	Slide the locking lever to the right (locked position). Then push down firmly on the cover until you hear it latch.
Cutter does not cut	Label slivers in cutter assembly	<p>Use a small tool such as tweezers or needle-nose pliers to carefully remove the media slivers from the cutter assembly. Use caution not to damage any of the components in the cutter assembly while removing media slivers. If you have concerns, please contact technical support for further assistance.</p> <hr/> <p style="text-align: center;"> WARNING</p> <p>Never attempt to remove slivers with your fingers. The cutter assembly includes very sharp components that can cause injury.</p>

Problem	Cause	Corrective Action
Hardware (continued)		
Printer jammed, cannot feed labels	Label exit chute is blocked causing label material to back up inside printer	<p>To clear the jam inside the printer:</p> <ol style="list-style-type: none"> 1. Open the printer cover. 2. Slide the locking lever to the unlock position. <p>Note: Unlocking retracts the platen so the cartridge can be removed. If there is a large jam, you may have to force the locking lever to the unlock position.)</p> <ol style="list-style-type: none"> 3. Remove the cartridge. 4. Use tweezers or a needle-nose pliers to clear label jam. <hr/> <p style="text-align: center;"> WARNING</p> <p>The print head is susceptible to damage. Using metal objects to remove jams can scratch, dent, or crack the print head. Use every precaution when clearing a jam.</p>
Power ON/OFF - Printer not working		
Printer does not power up when turned on.	Battery pack is not charged.	Attach the AC Adapter to the printer and plug into an electrical outlet. This will supply immediate power while charging the battery at the same time.
Screen freezes	User interface error.	<ol style="list-style-type: none"> 1. Press Power button to turn the printer off. <p>If Power button does not shut down printer:</p> <ol style="list-style-type: none"> 2. Remove the AC adapter (if using one). 3. Remove the battery pack, then immediately re-insert. 4. Power ON the printer.
Printer frequently powers OFF.	Battery is low.	Attach the AC Adapter to the printer and plug into an electrical outlet. This will supply immediate power while charging the battery at the same time.

Problem	Cause	Corrective Action
Power ON/OFF - Printer not working (continued)		
Printer frequently powers OFF.	Auto shutoff timing.	Adjust the Shut Off Delay timing in the Setup>Config menu. (See page 29 .)
Printer not responding	Battery is dead.	Attach the AC adapter to provide power to the printer and charge the battery. OR Install a new battery.
Error - “Cut while printing”	Operating cutter while labels are still printing.	<ol style="list-style-type: none"> Cut through the material completely. Press Clear  key to clear error. Reprint the label(s).
Print Quality		
Poor print quality	Battery pack may be worn out and not properly holding a charge.	Battery life is approximately one to three years, depending on its use and care. Order a replacement battery pack.
Poor print quality.	Dust or adhesives accumulated on the print head.	Clean the print head. (Refer to page 104 for instructions on cleaning the printer.)
Poor print quality	Media not usable.	Try another media cartridge.

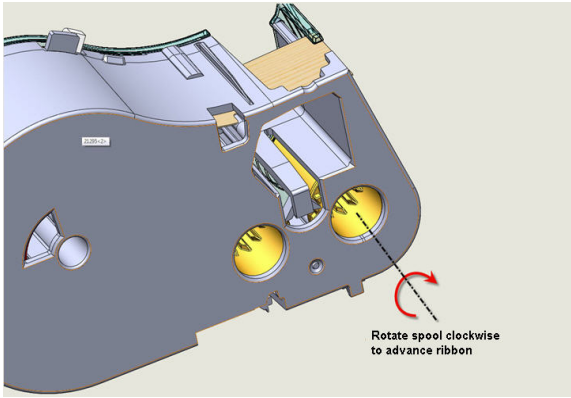
Problem	Cause	Corrective Action
Print Quality (continued)		
Void areas or lines appear on printed text.	Ribbon wrinkling.	<ol style="list-style-type: none"> 1. Remove the cartridge from the printer and advance the ribbon by rotating the take-up spool clockwise until the wrinkled/damaged ribbon is no longer visible (typically about one or two full turns). 2. Reinstall the cartridge and continue printing normally. <p>OR, try a new cartridge.</p>
 <p style="text-align: right; font-size: small;">Rotate spool clockwise to advance ribbon</p>		
Labels		
Printer will not feed labels.	The leading edge of the label roll is uneven or torn (not a straight edge).	Use a pair of scissors to cut a straight leading edge on the label roll.
Compressed print, poor registration	Dirty platen roller	Make sure the last cut label has been removed from the label tray. Clean the platen roller. (See page 104 for cleaning information.)
Poor registration on die cut labels	Damaged label notch	<p>Use a pair of scissors to cut a straight leading edge on the label roll.</p> <p>Use proper care when handling cartridges to avoid damaging label material.</p>

Problem	Cause	Corrective Action
Labels (continued)		
Error - "Out of Media"	Label/media memory device has counted down to zero. Circuit board on the roll holder core of label/media contains a memory device that tells the printer how much unused material remains on the label/media supply. Reuse of the roll holder with memory device will eventually count down to zero and give error	<ol style="list-style-type: none"> 1. Replace label/media or label/media roll holder. 2. Press [CLEAR/ESC] key to clear error.
Error - "No media installed"	Damaged circuit board on label/media roll.	<ol style="list-style-type: none"> 1. Replace label/media roll. 2. Press [CLEAR/ESC] key to clear error
Error - "No media installed"	Damaged contacts in receiver slot of lower printer base.	Contact Technical Support.
Error - "Top of form"	Label/media or ribbon has caused jam	<ol style="list-style-type: none"> 1. Clear any jams by opening the printer cover and removing an excess labels in the feed roller or exit chute areas. 2. Press [CLEAR/ESC] key to clear error.
Program		
File incompatible with installed media	A saved file (or power off file) was designed for media not currently installed.	Install correct media.
Incompatible Media for chosen application	The labels installed cannot accommodate the application requirements. (E.g., attempting to run a 110-Block application on die cut media.)	Install correct media.
Invalid terminal repeat value entered.	The value entered is out of the range.	The acceptable range is between the minimum of 0.2 inch to the maximum of 40 inches.

Cleaning the Printer

Cleaning the printer will improve print quality and legibility. It also increases output, machine life, printer reliability and performance.

Display Screen

To clean the display screen:

1. Lightly moisten a soft (non-scratching) cloth with isopropyl alcohol.

OR

Use pre-moistened static-free cloths available with the Brady PCK-6 Cleaning Kit.

2. Gently wipe the display screen until clean.

Internal Components

The only internal components that may require cleaning are the print head and platen roller.

To clean the internal components:

1. Turn the printer off.
2. Open the printer cover and remove any cartridge currently in the printer.

Note: Make sure the locking lever is in the UNLOCK position. If not, you will not be able to access the print head.

3. Using a lint-free swab moistened with isopropyl alcohol (or a swab from the Brady PCK-6 Cleaning Kit), gently swab the print head.
4. With the same moistened swab, gently brush the platen roller.

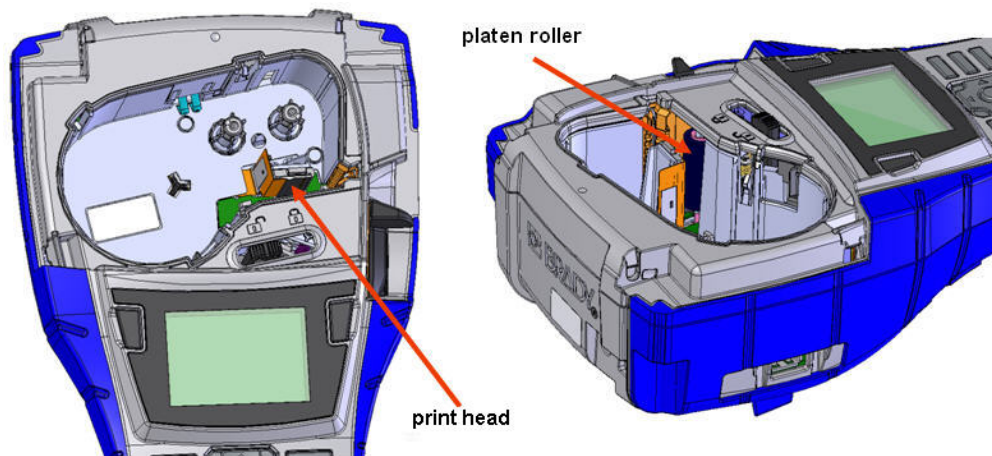

Figure 39 • Print head and platen roller in cartridge bay

Electrical

Exit

Fire

First Aid

CLP/GHS

HSID

Greek

Ω	σ	π	θ
Ψ	Α	Χ	α
β	Σ	Δ	Φ
Υ			

International

Laboratory

	STERILE		LOT
STERILE A		STERILE EO	
STERILE R		STERILE !	
CONTROL		CONTROL -	
CONTROL +		IVD	REF
SN	IN ANALYSIS		

Laboratory (cont.)

CONFIDENTIAL			

Mandatory



Misc

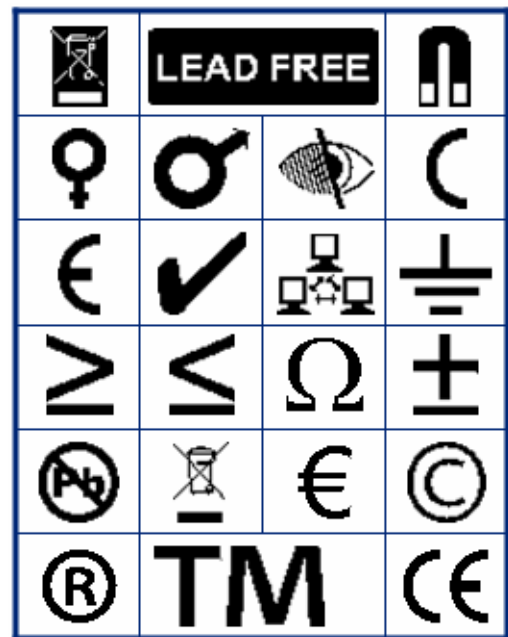

Packaging



PPE



Prohibition



Public Info



Safety



Warning



WHMIS



