

IDXPERT™ USER MANUAL

IDXPERT™
HANDHELD LABELER



IDXPERT™
HANDHELD LABELER
KEYBOARD LAYOUT



*For quick start-up information, please refer to the **IDXPERT™ Handheld Labeler Quick Start Guide**.*

www.bradyid.com/idxpert
www.bradyeurope.com



6555 West Good Hope Road, Milwaukee, WI 53201
1-888-BRADYGO (1-888-272-3946)

Copyright

This manual is copyrighted with all rights reserved. No portion of this manual may be copied or reproduced by any means without the prior written consent of Brady Corporation.

While every precaution has been taken in the preparation of this document, Brady assumes no liability to any party for any loss or damage caused by errors or omissions or by statements resulting from negligence, accident, or any other cause. Brady further assumes no liability arising out of the application or use of any product or system described, herein; nor any liability for incidental or consequential damages arising from the use of this document. Brady disclaims all warranties of merchantability of fitness for a particular purpose.

Trademarks

IDXPERT[™] is a trademark of Brady Corporation.

Font Fusion[™] is a registered trademark of Bitstream®.

Brady reserves the right to make changes without further notice to any product or system described herein to improve reliability, function, or design.

© 2006 Brady Corporation. All Rights Reserved.

Revision A, 09/2006

Firmware Version 2.0

Brady Corporation

6555 West Good Hope Road

P.O. Box 2131

Milwaukee, WI 53201

Main Switchboard: (800) 541-1686

(414) 358-6600

FAX: (800) 292-2289

Sales/Customer Support: (800) 537- 8791

Regulatory Information

Note: This equipment has been tested and found to comply with the limits for a Class A digital device, pursuant to part 15 of the FCC Rules. These limits are designed to provide reasonable protection against harmful interference when the equipment is operated in a commercial environment. This equipment generates, uses, and can radiate radio frequency energy and, if not installed and used in accordance with the instruction manual, may cause harmful interference to radio communications. Operation of this equipment in a residential area is likely to cause harmful interference in which case the user will be required to correct the interference at his/her own expense.

The user is cautioned that any changes or modifications not expressly approved by Brady Corporation could void the user authority to use the equipment.

This is a Class A product. In a domestic environment this product may cause radio interference, in which case the user may be required to take adequate measures.

Canada

This Class A digital apparatus meets all requirements of the Canadian Interference-Causing Equipment Regulations.

Cet appareil numérique de la classe A respecte toutes les exigences du Règlement sur le matériel brouilleur du Canada.

Europe



In accordance with the European WEEE Directive, this device needs to be recycled in the European Union country in which it was purchased.

Brady Warranty

Brady products are sold with the understanding that the buyer will test them in actual use and determine for him or herself their adaptability to his/her intended uses. Brady warrants to the buyer that its products are free from defects in material and workmanship, but limits its obligations under this warranty to replacement of the product shown to Brady's satisfaction to have been defective at the time Brady sold it. This warranty does not extend to any persons obtaining the product from the buyer.

THIS WARRANTY IS IN LIEU OF ANY OTHER WARRANTY, EXPRESS OR IMPLIED INCLUDING, BUT NOT LIMITED TO ANY IMPLIED WARRANTY OF MERCHANTABILITY OR FITNESS FOR A PARTICULAR PURPOSE, AND OF ANY OTHER OBLIGATIONS OR LIABILITY ON BRADY'S PART. UNDER NO CIRCUMSTANCES WILL BRADY BE LIABLE FOR ANY LOSS, DAMAGE, EXPENSE OR CONSEQUENTIAL DAMAGES OF ANY KIND ARISING IN CONNECTION WITH THE USE, OR INABILITY TO USE, BRADY'S PRODUCTS.

Technical Support

Choose one of the following options to contact system support provided by Brady Corporation:
U.S.

Phone: (800) 643-8766, Monday – Friday 6:30 a.m. – 6:30 p.m. CST

Fax: (414) 358-6767

E-Mail: tech_support@bradycorp.com

Assistance is available 24 hours per day / 7 days per week. Go to www.bradyid.com and then select **Knowledge Base** from the left-hand panel.

Belgium / Luxembourg

Phone: 0903/99 438

Fax: +32 52 457 800

E-Mail: tsbelgium@bradycorp.com

Italy

Phone: +39 02 96 28 60 14

Fax: +39 02 96 70 08 62

E-Mail: tsitaly@bradycorp.com

UK / Ireland

Phone: +44 1295 228 205

Fax: +44 1295 27 17 55

E-Mail: tsuk@bradycorp.com

Mexico

Phone: 01 800 112 7239

Fax: 52 55 5527 55 86

E-Mail: bradymexico@bradycorp.com

Spain

Phone: +33 437 245 234

Fax: +33 472 74 45 54

E-Mail: tsspain@bradycorp.com

Canada

Phone: 1-888-262-7576

Monday – Friday 8:00a.m. – 4:00p.m. EST

E-mail: techsuppcanada@bradycorp.com

Website: www.bradycanada.com

Africa, Denmark, Israel, Middle East, Turkey, Eastern Europe, Greece,

Portugal, Malta, Russia

Phone: +32 52 457 397

Fax: +32 52 457 800

E-Mail: tsbelgium@bradycorp.com

France

Phone: +33 169.296 717 or +800 917 161

Fax: +33 169 296 718

E-Mail: tsfrance@bradycorp.com

Germany / Austria / Switzerland

Phone: +49 6103 75 98 451

Fax: +49 6103 7598 670

E-Mail: tsgermany@bradycorp.com

Sweden / Norway / Finland

Phone: 46 85 90 057 33

Fax: 46 85 90 818 68

E-Mail: tssweden@bradycorp.com

Brazil

Phone: (55 11) 4166-1540

Fax: (55 11) 4166-1501

E-Mail: at@bradycorp.com

Latin America & Caribbean

Phone: (414) 438-6868

Fax: (414) 438-6870

E-Mail: Tech_Support@bradycorp.com

Netherlands

Phone: 0900/0400 439

Fax: +32 52 457 800

E-Mail: tsbelgium@bradycorp.com

Table of Contents

CHAPTER 1	INTRODUCTION.....	1
	PACKAGE CONTENTS	1
	PRODUCT REGISTRATION.....	1
	ABOUT THE USER MANUAL	1
	ADDITIONAL USER DOCUMENTATION	2
	TECHNICAL SPECIFICATIONS	2
CHAPTER 2	PRINTER COMPONENTS	4
	KEYPAD LAYOUTS	4
	BATTERY COMPARTMENT.....	5
	CONNECTIONS	5
	ACCESSORIES FOR YOUR IDXPERT™ HANDHELD LABELER	5
	MATERIAL CARTRIDGES	6
CHAPTER 2	GETTING STARTED	7
	SETTING UP THE PRINTER.....	7
CHAPTER 3	USING THE DISPLAY SCREEN, MENUS, AND KEYPAD	8
	THE DISPLAY SCREEN	8
	THE GENERAL ID MENU	8
	CONTRAST CONTROL	8
	GENERAL ID MENU BASICS	9
	SETUP FOR PRINTING FROM A PC.....	10
	GENERAL ID MENU SELECTIONS.....	10
	DATACOMM & T-BLOCK MENU BASICS	11
	DATACOMM & T-BLOCK MENU SELECTIONS	12
	GUIDE TO KEYS.....	13
CHAPTER 4	CREATING LABELS USING THE GENERAL ID MENU	15
	CREATING A BASIC LABEL.....	15
	FONTS.....	16
	SYMBOLS.....	18
	INTERNATIONAL CHARACTERS	19
	FORMATTING USING GENERAL LABEL SETTINGS	19
	FORMATTING USING WIREMARKER LABEL SETTINGS	20
	JUSTIFYING LEGENDS.....	21
	ROTATING LEGENDS	21
	PRINTING LABELS	22
CHAPTER 5	CREATING LABELS USING THE DATACOMM & T-BLOCK MENU.....	23
	PATCH PANEL LABELS	23
	TERMINAL BLOCK LABELS	25
	66-BLOCK LABELS	26
	110-BLOCK LABELS	27
	BIX-BLOCK LABELS	28
	DESI STRIPS.....	29
	BLANK PAIR TYPE.....	30

HORIZONTAL SERIALIZATION	31
BACKBONE SERIALIZATION	32
CHAPTER 6 GENERAL SETTINGS	35
SETTING THE TIME/DATE STAMP	35
PRINTING THE TIME/DATE STAMP	36
SETTING UNITS.....	36
SETTING LANGUAGE	37
CHAPTER 7 ADVANCED FEATURES	38
CONTINUOUS MEDIA.....	38
ZONES ON LABELS	39
GENERAL SERIALIZATION OF LABELS	40
BARCODE LABELS.....	42
CHAPTER 8 MEMORY	44
SAVING A LABEL TO MEMORY	44
RECALLING A LABEL FROM MEMORY	44
DELETING A LABEL FROM MEMORY	45
CHAPTER 9 MAINTENANCE	46
CLEANING	46
ACCESSORY PARTS LIST	47
CHAPTER 10 TROUBLESHOOTING	48
TROUBLESHOOTING GUIDE.....	48
ERROR MESSAGES.....	49
APPENDIX A GENERAL ID MENU TREE	50
APPENDIX B DATACOMM & T-BLOCK MENU TREE	51
APPENDIX C FONT SIZE CHART	52
APPENDIX D SYMBOL LIBRARY	54
APPENDIX E GLOSSARY OF TERMS.....	55

Chapter 1 Introduction

This chapter contains introductory information about the IDXPERT™ Handheld Labeler as well as information about the User Manual.

Package Contents

Before you begin setting up the printer, verify that you have received the following items in your packaging:

- ❑ IDXPERT™ Handheld Labeler
- ❑ Hard Case
- ❑ Free Media Cartridge: XC-1500-580-WT-BK
- ❑ Communications Cable
- ❑ Product CD containing:
 - Quick Start Guide—11 languages
 - User Manual—11 languages
 - Link to Product Registration/Warranty
 - Link to Printer Driver
- ❑ Printed Quick Start Guide—4 languages

Save Your Packaging

The packaging surrounding your IDXPERT™ Handheld Labeler should be saved in the event of any future shipments of the printer and accessories.

Product Registration

Register your IDXPERT™ Handheld Labeler online at www.bradyid.com/idxpertregistration.



WARNING: *Never ship the IDXPERT™ Handheld Labeler without first removing the alkaline batteries and disengaging the print head.*

About the User Manual

This manual contains information on the features, functions, and maintenance requirements for the IDXPERT™. Important information found in this manual is marked as follows:



WARNING: *May cause physical injury. May also cause damage to equipment and cause data loss.*



Note: *Helpful additional information and tips for use.*

Additional User Documentation

Quick Start Guide

Do you want to create and print a label fast? See the IDXPERT™ *Quick Start Guide*, included with your printer, for basic instructions on creating and printing labels.

Technical Specifications

The IDXPERT™ Handheld Labeler has the following physical and environmental characteristics:

Physical Specifications

	ABC Verison		Keyboard Version	
	Metric	U.S.	Metric	U.S.
Dimensions	95.25 x 292.1 x 127 mm.	3.75" x 11.5" x 5"	190.5 x 241.3 x 88.9 mm	7.5" x 9.5" x 3.5"
Weight—Printer only	.75 kg	1.65 lbs.	.77 kg	1.70 lbs.
Weight—Printer and Cartridge	.95 kg	2.1 lbs.	.98 kg	2.15 lbs.
Weight—Printer and Batteries	.88 kg	1.95 lbs.	.91 kg	2 lbs.
Weight—Printer, Cartridge, and Batteries	1.09 kg	2.4 lbs.	1.11 kg	2.45 lbs.

Environmental Specifications

	Operation	Storage
Temperature*	4° to 40° C (40° to 105° F)	-18° to 60° C (0° to 140° F)
Relative Humidity	20% to 95% (non-condensing)	10% to 80% (non-condensing)

*Exposing the IDXPERT™ Handheld Labeler to direct sunlight is not recommended.

POWER: Six AA 1.5V  Alkaline Batteries or AC Adapter 9V ; 3.3A.

Certification

The IDXPERT™ Handheld Labeler complies with the following:

United States and Canada

- UL/CSA 60950-1
- FCC Part 15 Class A
- FCC Title 47, Part 15, Subpart B, Class A limits
- ANSI/UL 60950
- AS/NZS 3548 Industry Canada ICES-003 Issue 4:2004
- CAN/CSA-C22.2 No. 60950

European Union

- EN60950
- CE CISPR-A
- EN55022:1998 +A1 and A2
- EN55024:1998 +A1 and A2
- EN61000-3-2:2000
- EN61000-3-3:1998 +A1 and A2
- WEEE/RoHS

Australia

- AS/NZS 3548:1995 + A1 and A2

Mexico

- NOM-019-SCFI-1998

Safety Information



WARNING: Please heed the following precautions before setting up and using your IDXPERT™ Handheld Labeler:

- Do not immerse the printer or A/C adaptor in water. Doing so may cause electrical shock.
- Avoid exposing the printer to unusually high levels of heat and humidity.
- Do not attempt to use batteries other than those recommended in this manual.

Chapter 2 Printer Components

This chapter provides the locations and descriptions of the components that make up the IDXPERT™ Handheld Labeler.

Keypad Layouts

The IDXPERT™ Handheld Labeler is available in two keypad layouts, *ABC Keypad* and *Keyboard Layout*. Although the keyboard layouts are different, the printers are operated and function identically.

ABC Keypad Version



Keyboard Layout Version



1. Material cartridge
2. Cutting Lever
3. Locking Lever
4. LCD Screen
5. Keypad

Battery Compartment

ABC Keypad Version

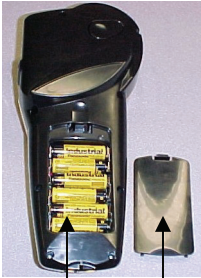

6

7

6. Battery Compartment
7. Battery Cover

Keyboard Layout Version

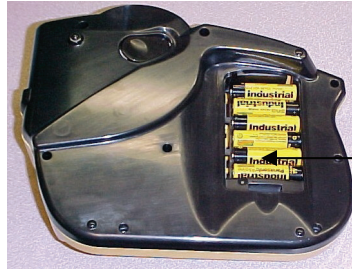

6

Connections



ABC Keypad Version—Connections are found on the *bottom* of the printer.

Keyboard Layout Version—Connections are found on the *top* of the printer.

Accessories for your IDXPERT™ Handheld Labeler

These accessories may be ordered from your Brady distributor:



Note: See the Accessory Parts List on page 47.

- Hard Case for Printer and Media
- Communications Cable
- A/C Power Supply
- Printer Cleaning Kit

Material Cartridges

Thanks to innovative smart-cell technology, the IDXPERT™ Handheld Labeler recognizes the label material and automatically adjusts to it, saving setup time and effort.



Note: Most label formatting default settings are based on the cartridge installed in the printer. Please see the chapters on formatting later in this manual for information on changing the default settings.

Cartridges Available for your IDXPERT™ Handheld Labeler

Material	Description	Applications
B-342	3:1 Heat-Shrink Polyolefin	Wire and cable marking (heat shrink sleeves)
B-412	Polypropylene	Patch panel ID, BIX block, 110 block, and Desi strips <i>Designed for outdoor and harsh environmental applications, especially wire and cable ID and product inventory ID</i>
B-422	Glossy Polyester	Component marking, electrical outlet and patch panel ID <i>Withstands exposure to numerous solvents; good adhesion to many surfaces including low surface energy plastics</i>
B-427	Self-laminating Vinyl	Wire and cable marking (self-laminating)
B-428	Metalized Polyester	Rating plate, product and asset ID <i>Withstands numerous solvents ad variable temperatures when applied to various surfaces</i>
B-432	Clear Polyester	Patch panel ID and BIX block <i>Withstands exposure to numerous solvents; adheres to many surfaces including metals, textured surfaces, and low surface energy plastics</i>
B-461	Self-laminating Polyester	Laboratory ID, self-laminating vial, tube, and slide ID <i>Withstands liquid nitrogen, freezer, autoclave, hot water bath, centrifuge</i>
B-483	Ultra Aggressive Glossy Polyester	General labeling, powder coated surface ID <i>High adhesion to textured metals and low surface energy plastics; specifically designed to adhere to powder-coated surfaces</i>
B-488	Matte Polyester	Laboratory ID, slides, plates, bottles, and general laboratory ID <i>Withstands Xylene, DMSO, ethanol, freezer, autoclave, hot water bath</i>
B-498	Vinyl Cloth (Repositionable)	Wire and cable marking (general adhesive), component marking, terminal blocks, general laboratory ID
B-499	Nylon Cloth (Permanent)	Wire and cable marking (general adhesive), component marking, terminal blocks, general laboratory ID
B-580	Indoor/Outdoor Vinyl	Pipemarkers, panel and switch ID, equipment ID, small safety signs, asset ID, bar code labels <i>Colored supplies and printing</i>

Chapter 3 Getting Started

This chapter provides instructions on setting up your IDXPERT™ Handheld Labeler and creating a basic label. Refer to the following chapter for details on how to use the keypad and menu.

Setting up the printer

Follow these steps to set up your printer prior to creating your first label.

Step 1. Install batteries or connect to power.

Insert six AA alkaline batteries (not included).

1. Remove the battery cover located on the backside of the printer.
2. Install the batteries as shown. See inside the battery compartment for the battery-positioning grid.
3. Close the battery compartment.



ABC Keypad Version

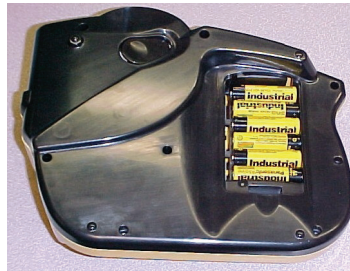

Keyboard Layout Version



Note: You can print up to 650 labels between battery changes.

The IDXPERT™ Handheld Labeler can also be powered by use of an A/C Power Supply. See the section on **Connections** on page 5.

Step 2. Replace material cartridge.



Note: Cut off any excess label material before removing an existing cartridge.

Your printer ships with a cartridge installed. Follow these instructions to replace the existing cartridge.

1. Turn the locking lever down to unlock the cartridge.
2. Locate the *cartridge release button* on the backside of the printer and push firmly to eject cartridge.
3. Remove the existing cartridge.
4. Install the new cartridge as shown.
5. Turn the locking lever up to lock both the cartridge and print head.

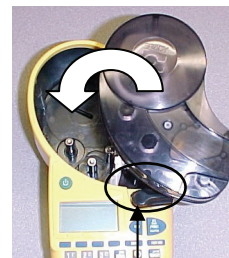

Locking Lever

Step 3. Turn the printer ON.

Press the **POWER** key.



Chapter 4 Using the Display Screen, Menus, and Keypad

This chapter provides information about the display screen, the **General ID Menu** and the **DataComm & T-Block Menu**. It also provides information about the keys found on the IDXPERT™ Handheld Labeler and their corresponding functions.

The Display Screen

When the Power button is pressed, the start-up display screen appears.

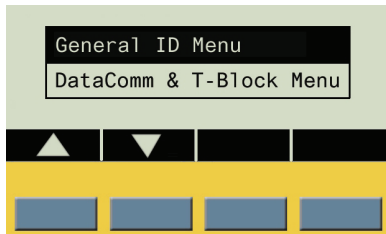

Start-Up Display Screen

The start-up display screen allows you to choose between the General ID menu options or the DataComm & T-Block menu options (use the blue softkeys beneath the up/down arrows to toggle between the two). The General ID Menu is highlighted by default.

When using either menu, the display allows you to see up to three lines of text and 16 characters per line. The display auto-scrolls when you enter more than the maximum displayed lines or characters. Use the arrows on your keypad to navigate the screen.



Note: The **DataComm & T-Block Menu** becomes available only when a dedicated datacomm part is inserted in the printer; otherwise, the start-up display screen opens directly to the **General ID Menu**.

The General ID Menu

Press **ENTER**  to select the **General ID Menu**.



General ID Menu Screen





The status bar, located on the bottom of the display screen, indicates the current text line, font size, and label format.



Note: If the label you are using allows for multiple zones, the label format will display as the zone number and total number of zones, for example **Z:1-2** (Zone 1 of 2 total zones); otherwise, the label format will be indicated as either **Gen** for general or **Wire** for wiremark.

Contrast Control

In order to change the contrast on the display, press  and then:

- Press  +  to *darken*.
- Press  +  to *lighten*.

General ID Menu Basics

This section provides basic instructions on using the **General ID Menu** as well as an overview of the menu selections. Use the menu and related softkeys to perform many of the label formatting commands.



Note: See Chapter 5— Creating Labels Using the General ID Menu for more information. Also see Appendix A —General ID Menu Tree.

Step 1. Press **MENU**. 

When the **MENU** key is pressed, a series of menu options appears. The blue softkeys correspond to the menu options on the screen.

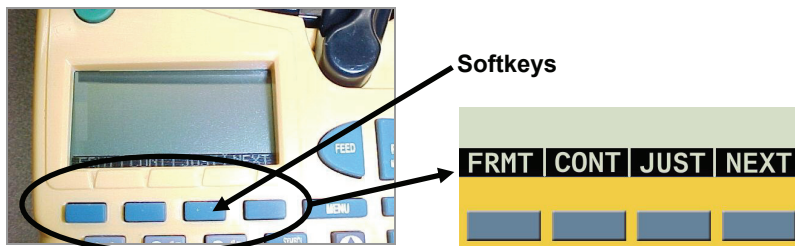

Step 2. Press **NEXT** to advance to the next set of menu options:

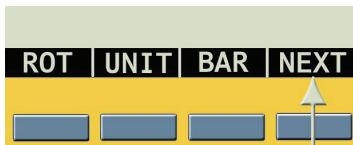

Step 3. Press **NEXT** again to advance to the next set of menu options:

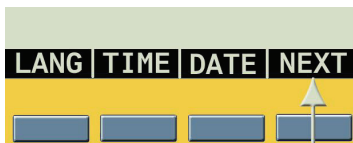

Step 4. Press **NEXT** again to advance to the last set of menu options:

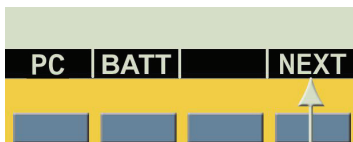

At this point, pressing **NEXT** again cycles back to the first set of menu options when the last set of menu options is reached.

Pressing **CLEAR/ESC**  exits the menu mode and returns you to the **General ID** display screen.

After returning to the **General ID** display screen, pressing **FUNCTION** + **MENU** returns you to the start-up display screen.

Setup for Printing from a PC

You may use your PC to create and print labels with your IDXPERT™ Handheld Labeler. First download the printer driver provided on your product CD (or download the latest printer driver firmware from Brady's website). Then connect the communications cable provided with your printer from the IDXPERT™ to your PC's communication port.

Step 1. On your IDXPERT™ Handheld Labeler, press **POWER**. 

Step 2. Press **ENTER**  to select the **General ID** display screen.

Step 3. Press **MENU**. 

Step 4. Press the **NEXT** softkey three (3) times until you advance to the **PC** option.

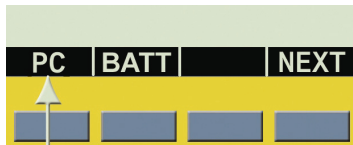

Step 5. Press the softkey beneath **PC** to enable PC connectivity. At this point your printer will be able to receive data and send it to print.

General ID Menu Selections

Following is a list of the *high-level* General ID Menu selections and the corresponding softkeys:

To perform formatting using the General ID Menu , press MENU and the corresponding softkey:	Softkey
Label Format —Select general or wiremarker labels. Wiremarker mode repeats text line(s) as many times as will fit on a label.	FRMT
Continuous —Set either auto or fixed length, and separator type, for terminal block and banner labels.	CONT
Justify —Set horizontal and vertical justification of label data.	JUST
Rotate —Set rotation of label data to 0, 90, 180, or 270 degrees.	ROT
Units —Change units—to inches, mms, or points—for displaying label and font sizes.	UNIT
Barcode —Add Code 39 and 128 with human readable text.	BAR
Set Time —Set time to print a real-time stamp on your label.	TIME
Set Date —Set date to print a real-time date stamp on your label.	DATE
Language —Change the default language.	LANG
Battery —View graphical indicator of energy remaining in battery.	BATT
PC —Connect to PC using communications cable.	PC

See *Appendix A—General ID Menu Tree* on page 50 for a listing of submenus related to each section.

DataComm & T-Block Menu Basics

This section provides basic instructions on using the **DataComm & T-Block Menu** as well as an overview of the menu selections. Use the menu and related softkeys to perform many of the label formatting commands.



Note: See Chapter 6—Creating Labels Using the DataComm & T-Block Menu for more information. Also see Appendix B—DataComm & T-Block Menu Tree.

To access the **DataComm & T-Block Menu**:

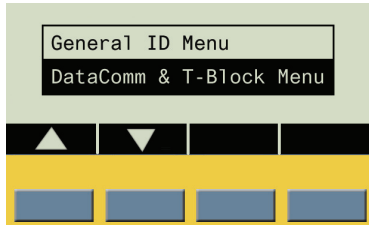

Start-Up Display Screen

Upon returning to the start-up display (or by turning the power off and on), the General ID Menu is highlighted by default. Use the blue softkeys beneath the up/down arrows to toggle to the **DataComm & T-Block Menu**.

Step 1. Press **ENTER**  to select the DataComm & T-Block Menu. The Select DataComm Application display screen appears:

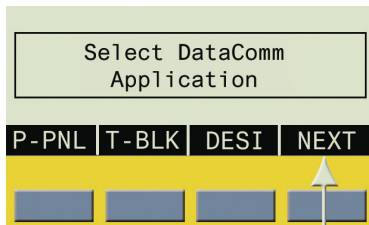

Step 2. Press **NEXT** to advance to the next set of menu options:

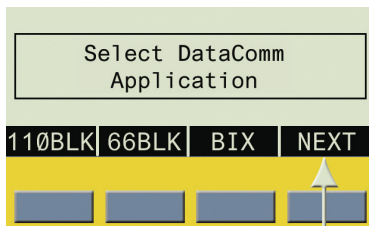

At this point, pressing **NEXT** again cycles back to the first set of menu options when the last set of menu options is reached.

Pressing **CLEAR/ESC**  exits the **DataComm & T-Block** menu mode and returns you to the **General ID** display screen.

After returning to the **General ID** display screen, pressing **FUNCTION + MENU** returns you to the start-up display screen.









DataComm & T-Block Menu Selections







Following is a list of the *high-level DataComm & T-Block Menu* selections and the corresponding softkeys:

To perform formatting using the DataComm & T-Block Menu , press MENU and the corresponding softkey:	Softkey
Patch Panel —The default values are as follows: Port Width: 0.60" Separator: LINE Justification: CENTER, CENTER Rotation: 90 degrees	P-PNL
Terminal Block —The default values are as follows: Length: 0.20" Separator: LINE Justification: CENTER, CENTER Rotation: 0 degrees	T-BLK
Desi Strip —The default values are as follows: Width: 1.94" Separator: NONE Justification: CENTER, CENTER Rotation: 90 degrees	DESI
110 Block —The default values are as follows: Pair Type: 4 Length: 1.2" for 4 pair (Length is based on pair configuration, so the following applies to the other pair configurations: 2 pair = .6", 3 pair = .9", 5 pair = 1.5", and Blank = 7.5") Separator: LINE Justification: CENTER, CENTER Rotation: 270 degrees (this is the only applicable rotation available)	110BLK
66 Block —The default values are as follows: Length: 0.20" Separator: NONE Justification: CENTER, CENTER Rotation: 0 degrees	66BLK
BIX Block —The default values are as follows: Pair Type: 4 Length: 1" for 4 pair (Length is based on pair configuration, so the following applies to the other pair configurations: 2 pair = .5", 3 pair = .75", 5 pair = 1.25", and Blank = 6.2") Separator: LINE Justification: CENTER, CENTER Rotation: 270 degrees (this is the only applicable rotation available)	BIX

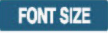
See *Appendix B—DataComm & T-Block Menu Tree* for a listing of submenus related to each section.

Guide to Keys

Key	Description
	<p>POWER—powers on the printer.</p> <p>Press the POWER button again to power off the printer. The printer automatically shuts off after 10 minutes of non-use, unless it is in PC mode.</p>
	<p>FUNCTION—accesses a secondary function or character when pressed along with the desired key.</p> <p><i>A secondary function or character is shown in yellow on each button.</i></p>
	<p>ARROW—adjusts cursor positioning by one character or one line.</p> <p>FUNCTION + ARROW—adjusts cursor positioning to the first or last character position or line.</p>
	<p>ENTER—creates a new line when typing text.</p> <p>Pressing ENTER confirms menu selection when in MENU mode.</p> <p>FUNCTION + CREATE ZONE—splits a label into multiple parts (continuous material only).</p>
	<p>FUNCTION + PREV ZONE—navigates to the previous zone when entering text and when viewing or editing previously entered text on continuous or die-cut labels (in pre-defined zones only).</p>
	<p>FUNCTION + NEXT ZONE—navigates to the next zone when entering text and when viewing or editing previously entered text on continuous or die-cut labels (in pre-defined zones only).</p>
	<p>DELETE—clears the character immediately behind the cursor position.</p> <p>FUNCTION + CLEAR/ESC—makes the following options available, depending on the menu you are using:</p> <p>GENERAL ID MENU:</p> <p><i>Clear Text Only</i>—Clears all text on a label.</p> <p><i>Clear All</i>—Clears all text and formatting, including font size.</p> <p><i>When in MENU mode, the Clear/Esc function backs out of the menu.</i></p> <p><i>This works whether or not you use it in conjunction with the Function key.</i></p> <p>DATAComm & T-BLOCK MENU:</p> <p><i>Clear Text Only</i>—Clears the text, but maintains all previously arranged formatting.</p> <p><i>Return to DataComm Menu</i>—Returns you to the Select DataComm Application display screen.</p> <p><i>Exit DataComm Menu</i>—Sends you to the General ID display screen.</p>
	<p>PRINT—prints one copy of the legend.</p> <p>FUNCTION + MULTI-PRINT—prints up to 99 copies of the legend.</p>

Key	Description
	FONT SIZE —displays font size and allows font size changes through softkeys. <i>See Appendix C—Font Size Chart.</i> Also toggles BOLD on/off.
	MENU —toggles through soft key menu options/displays additional soft key choices.
	FEED —feeds material through the printer without printing. Use for fixed length continuous labels in order to advance the label strip to the cut position.
	MEMORY —accesses Save, Recall, and Delete softkeys used to store legends. FUNCTION + BARCODE —toggles between text and barcode mode.
	SERIAL —performs a standard serialization of the character on which the cursor is placed. A <i>serialization</i> results in a series of label data that is incremented by one number (0-9) and/or one letter (A-Z, a-z). The type of label you are generating dictates specific serialization functionality. FUNCTION + SYMBOL —accesses the symbol library. <i>See Appendix D—Symbol Library.</i>
	SPACE —creates a space between characters when creating legends. FUNCTION + CAPS LOCK —toggles CAPS on and off.
	FUNCTION + Z —brings up a selection of international characters. Use either the softkey or keypad arrows to navigate the character menu.

Chapter 5 Creating Labels Using the General ID Menu

This chapter provides information for creating, formatting and printing labels using the **General ID Menu**, including information on changing font sizes and bold status. It also provides instructions for adding symbols and international characters to a label.

Creating a Basic Label

Follow these steps to create and print a basic label. For details and information on advanced features, refer to the chapters that follow in this manual.



*Note: See the **IDXPERT™ Handheld Labeler Sample Label Tutorial** for step-by-step instructions on creating a variety of labels.*

Step 1. Press **POWER**.



Step 2. Press **ENTER** to select the **General ID Menu** (highlighted by default).



Step 3. Press **FONT SIZE**.



The display screen shows the current font size, bold status, and auto size status.

```
FONT: 10 pt
Bold: OFF
Auto Size: OFF
```



*Note: See **Appendix C—Font Size Chart** to view available font sizes.*

Step 4. Use the up/down arrow softkeys, or the arrows on your keypad to select a font size. [▲] [▼]

Step 5. Press the **BOLD** softkey to toggle bold ON or OFF.

Step 6. Press the **AUTO** softkey to toggle auto sizing ON or OFF.

Step 7. Press **ENTER**.



Step 8. Type desired text and/or characters.
Press **ENTER** to add additional lines of text and/or characters.



*Note: You may also select from a list of symbols to include on your label. See **Appendix D—Symbol Library** to view selection.*

Step 9. Press **PRINT**. For multiple copies, press **FUNCTION + PRINT/MULTI-PRINT**.



Step 10. Pull the cutter lever down to cut the label.



*Note: If you press **FUNCTION + CLEAR/ESC** while creating labels using the **General ID Menu**, the following options appear on the display screen:*

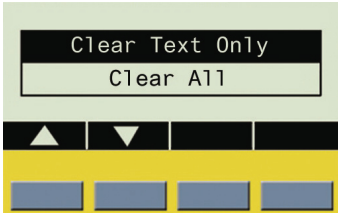

- Clear Text Only—Select this to clear all text on your label.
- Clear All—Select this to clear all text and formatting, including font size. This also applies to all zones in a multi-zone format.

Fonts

Fonts are available in these point sizes: 4 pt., 6 pt., 7 pt., 9 pt., 10 pt., 13 pt., 16 pt., 20 pt., 26 pt., 32 pt., 38 pt., 42pt., 45pt., 51pt., 55pt., 60pt., 65pt., 70pt., 76 pt., 102 pt., and AUTO. Symbols and numbers can also be printed in these font sizes. The IDXPERT™ Handheld Labeler also offers a 126 pt. (1.25", 31.75mm) font for uppercase characters only.



Note: Refer to Appendix C—Font Size Chart on page 52 to view available font sizes.

Default Font Size

When a cartridge is loaded and the unit is turned on, the IDXPERT™ Handheld Labeler reads the label size information stored in the smart cell. This information is used to automatically set an initial font size for your label. The method used to set this default is intended to help approximate an optimal starting point for sizing your text.

For continuous printed labels (banners), the default font size is the largest font that prints on the selected marker width in horizontal orientation.

Changing the Font Size

The maximum font size selectable for a particular label line depends on several factors including label size, number of characters of text entered on the label line, number of lines of text entered on the label, rotation, justification, and the font sizes chosen for the label lines.

The printer allows a maximum of 75 characters per line and 23 lines per label. These limits are dependent on factors such as number and type of characters, font size, and label type.



To set or change a font size:

Step 1. Press **FONT SIZE**. 

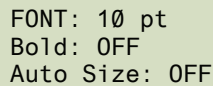
The display screen shows the current font size, bold status, and auto size status.



FONT: 10 pt
Bold: OFF
Auto Size: OFF

Step 2. Use the up/down arrow softkeys, or the arrows on your keypad to select a font size.  

Step 3. Press **ENTER**. 

Once the font is set for a label line, the size remains the same for any new lines that follow and remains at the size you choose until you decide to change it.

If you attempt to enter too many characters on a label line, you will receive this error message: “Cannot Fit.” To allow more characters to fit on the line, you must decrease the font size.

Creating Boldface Text

Boldface text is created on a line-by-line basis.

To create a boldface line of text:

Step 1. Place your cursor anywhere in the line of text.

Step 2. Press **FONT SIZE**. 

Step 3. Press the softkey beneath **BOLD**.

Step 4. Press **ENTER**. 

Step 5. Press the **Bold** softkey to toggle on and off on a line-by-line basis. When Bold is toggled to ON, the bold formatting stays on until OFF is selected.

Auto Sizing Text

The auto size feature works on a whole label/all zones basis, not line-by-line. As text and/or characters are entered, if they do not fit, the printer calculates a new size, allowing the largest font size required to fit on the current line.

To auto size text and/or characters:

Step 1. Press **FONT SIZE**. 

Step 2. Press the softkey beneath **AUTO**.

Step 3. Press **ENTER**. 

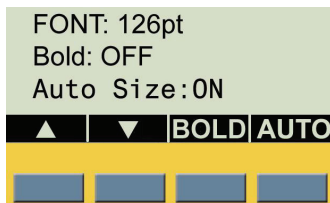

Press the **Auto** softkey to toggle auto sizing on and off. When **AUTO** is toggled to ON, the **Auto Size** feature stays on until OFF is selected; however, you can still manually alter the font size of individual lines while the **Auto Size** feature is ON.



Note: When rotation is altered, **Auto Sizing** adjusts accordingly; if rotation won't allow smallest font to fit, the error message "**Cannot Fit**" appears. Also, if rotation will cause cropping of any text lines, the same "**Cannot Fit**" message appears, and no rotation will occur.

Symbols

The IDXPERT™ Handheld Labeler offers a variety of symbols in these categories: Refer to *Appendix D–Symbol Library* on page 54 for a list of symbols available for printing within each category.

- Electrical/Voice Data
- Greek
- Mandatory/PPE
- Warning
- Prohibition
- Fire/First Aid
- Hazardous Materials (WHIMIS)
- Arrows & Misc.

To select a symbol:

Step 1. Place your cursor anywhere in the line of text.

Step 2. Press **FUNCTION**  + **SERIAL**  (**SYMBOL**).

A list of symbol categories appears on the display screen:

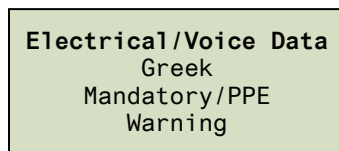

Use the softkey arrows or the arrows [▲] [▼] (up/down) on your keypad to scroll through the symbol categories.

Step 3. Press **ENTER**  to select the desired symbol category.
The symbols appear, one at a time, for the category selected.

Step 4. Use the softkey arrows or the arrows [▲] [▼] (up/down) on your keypad to scroll through the symbols in the selected category.

Step 5. Press **ENTER**  to select the desired symbol.

The symbol will appear on the display screen at the current cursor position. Some symbols will appear as a generic character symbol  on the display, but will appear as intended when printed.

Symbols can be printed in all font sizes. See the section on *Fonts* on page 16 for instructions on changing font sizes.

International Characters

The IDXPERT™ Handheld Labeler offers these international characters corresponding to the 10 non-English languages offered.



International Characters—Upper Case

À	Á	Â	Ã
Ä	Å	Æ	Ç
È	É	Ê	Ë
Ì	Í	Î	Ï
Ñ	Ò	Ó	Ô
Õ	Ö	Ø	Œ
Ù	Ú	Û	Ü
Ý	Ý	ÿ	Ž

International Characters—Lower Case

à	á	â	ã
ä	å	æ	ç
è	é	ê	ë
ì	í	î	ï
ñ	ò	ó	ô
õ	ö	ø	œ
ù	ú	û	ü
ý	ý	ÿ	ž

To select an international character:

- Step 1.** Press **FUNCTION**  + **Z** .
- A list of international characters appears on the display screen.
- Step 2.** Press either the softkeys or keypad arrows [**▲**] [**▼**] [**◀**] [**▶**] to navigate the character menu.
- Step 3.** When the desired character is reached, press **ENTER**.  The selected international character is inserted in the cursor position.

Formatting Using General Label Settings



Note: Most label formatting default settings are based on the cartridge installed in the printer.

The IDXPERT™ Handheld Labeler allows printing of both general and wiremarker labels. When you select *general* format, text will be printed on the label in the way that you entered it. When you create a *wiremarker* label, each line of text is repeated as many times as will fit on the label. See **Formatting Using Wiremarker Label Settings** on page 20 for information on creating wiremarker labels.

While in the **General ID Menu**, the IDXPERT™ defaults to the *General* setting for most cartridges except those containing self-laminating label material. In most cases, you will only need to set label format to *General* if you have been working in wiremarker mode. The current format—Gen or Wire—is displayed on the status bar.

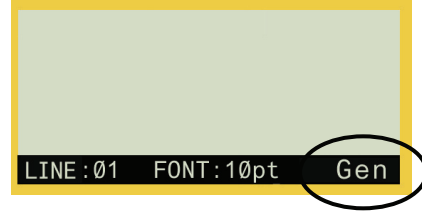

To work with General (non-wiremarker) labels:

Step 1. Press **MENU**. 

Step 2. Press the softkey beneath **FRMT**.

Step 3. Press the softkey beneath **GEN**. The format style is shown on the display screen.

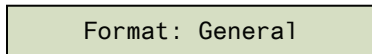

Step 4. Press **ENTER**. 

Formatting Using Wiremarker Label Settings

When you create a wiremarker label, each line of text is repeated as many times as will fit on the label. Wiremarkers allow for full 360° rotational viewing of the printed information making this label type useful for marking wires, cables, vials, tubes, or any cylinder.

123	123
123	ABC
123	123
123	ABC



Note: The alignment default for wiremarker text is CENTERED.

To work with Wiremarker labels:

Step 1. Press **MENU**. 

Step 2. Press the softkey beneath **FRMT**.

Step 3. Press the softkey beneath **WIRE**. The format style is shown on the display screen.

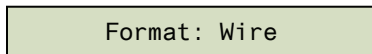

Step 4. Press **ENTER**. 

For wiremarker labels, the text line(s) is repeated as many times as will fill the printable area. This is automatically calculated by the smart-cell.

Justifying Legends

Use the Menu selections to justify your legends horizontally or vertically. Selections for each type of justification are as follows:

Horizontal			Vertical		
123	123	123	123	123	123
Left	Center	Right	Top	Center	Bottom

To justify your legend:

Step 1. Press **MENU**. 

Step 2. Press the softkey beneath **JUST**.

Step 3. Select justification.

- For *horizontal* justification, press **HORIZ**, then **LEFT**, **CENT**, or **RIGHT**.
- For *vertical* justification, press **VERT**, then **TOP**, **CENT**, or **BOT**.

Step 4. Press **ENTER**. 

Rotating Legends

Use the Menu selections to rotate your legends 0, 90, 180, or 270 degrees.

EXAMPLES:

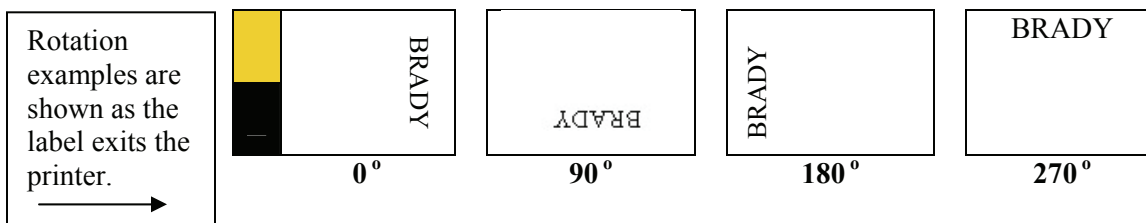

To rotate your legend:

Step 1. Press **MENU**. 

Step 2. Press the softkey beneath **NEXT**, and then **ROT**.

Step 3. Press **0**, **90**, **180**, or **270**.

Step 4. Press **ENTER**. 

Printing Labels

To print one copy of a label:

Press **PRINT**.



Note: If your label cartridge runs out of labels before the print job is completed, the print job will be aborted. You will need to start a new print job to continue printing the remaining labels.

To print multiple copies of a label:

Step 1. Press **FUNCTION**  +  (**MULTI-PRINT**).

The following prompt appears on the display screen:

No. of Copies?	1
----------------	---

Step 2. Enter a number between 1 and 99.

Step 3. Press **ENTER**.



Patch Panel Labels



Note: See *DataComm & T-Block Menu Selections* for a list of the high-level DataComm & T-Block Menu selections, their default values, and the corresponding softkeys.

This example outlines the functionality required to create a Patch Panel using the DataComm & T-Block menu. It assumes use of a dedicated Patch Panel part, either 1/2" or 3/8" in width.

To create a Patch Panel label:

- Step 1.** Insert a dedicated part (XC-375-422, XC-500-422, or continuous B412 parts in .375" and .5" widths). The printer reads the smart-cell settings and automatically displays the screen allowing you to choose between the General ID Menu and DataComm & T-Block Menu. Upon selecting the DataComm & T-Block Menu, the following datacomm menu options appear above the softkeys:

P-PNL, T-BLK, DESI, 110BLK, 66BLK, BIX.



Note: To escape to the *General ID Menu* screen press **FUNCTION + CLEAR/ESC**.

- Step 2.** Press the **P-PNL** softkey. The default **Patch Panel** information automatically appears on the display screen as shown below (width in inches or millimeters, depending on your settings*):

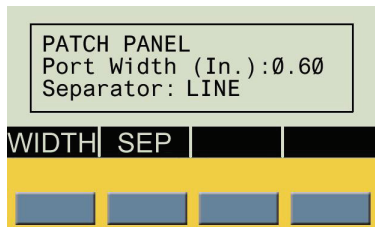

*See *Setting Units* on page 36 for instruction on setting units to inches or millimeters.

- Step 3.** To set or accept the width, do one of the following:
- Press the **ENTER** key to accept the default, or
 - Press the **WIDTH** softkey, enter a new width, and press **ENTER**.
- Step 4.** The separator attribute defaults to LINE, but you can change this by pressing the **SEP** softkey. If this is done, the following screen appears:

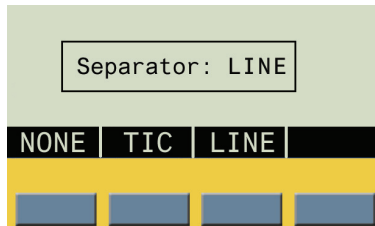

- Step 5.** Press the desired separator type softkey (**NONE**, **TIC**, or **LINE**) and then press **ENTER** to confirm. The editor display screen appears with the datacomm label type title in the upper left corner. One zone (or port) is viewed at a time (*see next page*).



Patch Panel Display Screen

Step 6. Enter the desired label data and do one of the following:

- Press the **ENTER** key to begin a second line, or
- Press **FUNCTION** + **CREATE ZONE** to move to a new zone (port).

Step 7. Use the **PREV ZONE** and **NEXT ZONE** keys to scroll through the zones created for the label. Patch panels can be viewed the same as if they were one large label.

Note also the following:

- You can create up to 12 zones per label.
- Font sizes can differ on a line-by-line and zone-by-zone basis. Rotation can also be changed on a zone-by-zone basis.
- One zone (or port) is viewed at a time (creation of a maximum of 12 zones is possible; when the label is recalled from memory, the first zone created appears).
- The example below shows a Patch Panel label that utilizes 12 zones with the first of the 12 zones shown:

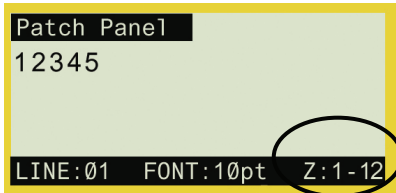

Step 8. Press **PRINT**. The label will feed to the cut position.

Lines print so that both the start and end lines show. *See example:*

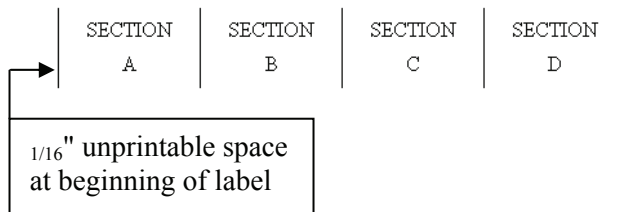

After printing, the display screen returns to displaying the label text in the **DataComm & T-Block Menu**.



Note: If you press **FUNCTION + CLEAR/ESC** while creating labels using the **DataComm & T-Block Menu**, the following options appear on the display screen:

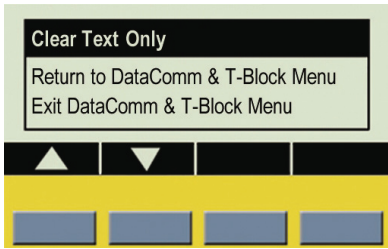

- **Clear Text Only**—Select this to clear all text and all zones on the label.
- **Return to DataComm & T-Block Menu**—Select this to return to the DataComm & T-Block Menu and the *Select DataComm Application* screen.
- **Exit DataComm & T-Block Menu**—Select this to return to the General ID Menu.

Terminal Block Labels



Note: See **DataComm & T-Block Menu Selections** for a list of the high-level DataComm & T-Block Menu selections, their default values, and the corresponding softkeys.

This example outlines the functionality required to create a Terminal Block label using the DataComm & T-Block menu. This example also assumes use of a dedicated terminal block part in one of the following widths: .24", .318", and .375". There are a maximum of 12 individual zones allowed for Terminal Block labels, with a limit on the number of characters per zone when numerous zones are being created.

To create a Terminal Block label:

- Step 1.** Insert a dedicated part (XC-240-498, XC-318-498, or XC-375-498). The printer reads the smart-cell settings and automatically displays the screen allowing you to choose between the General ID Menu and DataComm & T-Block Menu. Upon selecting the DataComm & T-Block Menu, the following datacomm menu options appear above the softkeys:
P-PNL, T-BLK, DESI, 110BLK, 66BLK, BIX.



Note: To escape to the **General ID Menu** screen press **FUNCTION + CLEAR/ESC**.

- Step 2.** Press the **T-BLK** softkey. The default **terminal block** information automatically appears on the display as shown below (in inches or millimeters, depending on your settings*):

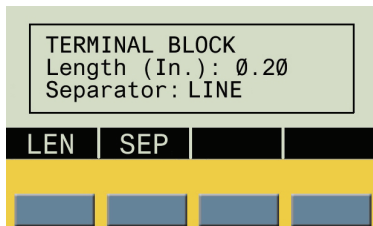

*See **Setting Units** on page 36 for instruction on setting units to inches or millimeters.

- Step 3.** To set or accept the length, do one of the following:
- Press the **ENTER** key to accept the default, or
 - Press the **LEN** softkey, enter a new length, and press **ENTER**.



Note: From this point, similar functionality is used as when working with Patch Panels. See **Patch Panel Labels** on page 23 for more information.

Terminal Block display screen examples:

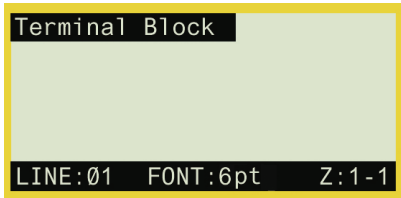

Display screen before text/zones entered

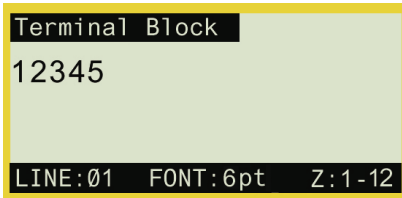

Display screen showing 12-zone label with the first of 12 zones displayed

66-Block Labels



*Note: See **DataComm & T-Block Menu Selections** for a list of the high-level DataComm & T-Block Menu selections, their default values, and the corresponding softkeys.*

This example outlines the functionality required to create a 66-Block label using the DataComm & T-Block menu. This example also assumes the use of a dedicated 66-Block label part (width = .375").

To create a 66-Block label:

- Step 1.** Insert a dedicated part (XC-375-498). The printer reads the smart-cell settings and automatically displays the screen allowing you to choose between the General ID Menu and DataComm & T-Block Menu. Upon selecting the DataComm & T-Block Menu, the following datacomm menu options appear above the softkeys:
P-PNL, T-BLK, DESI, 110BLK, 66BLK, BIX.



*Note: To escape to the **General ID Menu** screen press **FUNCTION + CLEAR/ESC.***

- Step 2.** Press **NEXT**, then the **66-BLK** softkey. The default **66-Block** information automatically appears on the display screen as shown below (in inches or millimeters, depending on user settings*):

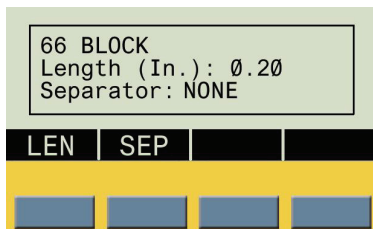

*See **Setting Units** on page 36 for instruction on setting units to inches or millimeters.

- Step 3.** To set or accept the length, do one of the following:
- Press the **ENTER** key to accept the default, or
 - Press the **LEN** softkey, enter a new width, and press **ENTER**.



*Note: From this point, similar functionality is used as when working with Patch Panels. See **Patch Panel Labels** on page 23 for more information.*

66-Block display screen examples:



Display screen before text/zones entered



Display screen showing 12-zone label with the first of 12 zones displayed

110-Block Labels



Note: See *DataComm & T-Block Menu Selections* for a list of the high-level DataComm & T-Block Menu selections, their default values, and the corresponding softkeys.

This example outlines the functionality required to create a 110-Block label using the DataComm & T-Block menu. 110-Block labels print based on user-selected pair configuration. This example assumes use of a dedicated 110-Block part (width = .475").

To create a 110-Block label:

- Step 1.** Insert a dedicated part (.475" x continuous in B412 and B422). The printer reads the smart-cell settings and automatically displays the screen allowing you to choose between the General ID Menu and DataComm & T-Block Menu. Upon selecting the DataComm & T-Block Menu, the following datacomm menu options appear above the softkeys: **P-PNL, T-BLK, DESI, 110BLK, 66BLK, BIX.**



Note: To escape to the *General ID Menu* screen press **FUNCTION + CLEAR/ESC.**

- Step 2.** Press **NEXT**, then the **110-BLK** softkey. The default **110-block** information automatically appears on the display screen as shown below (pressing **NEXT** advances menu options):

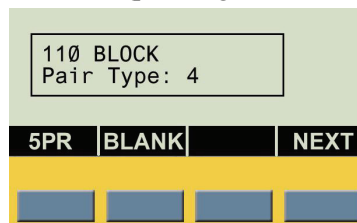
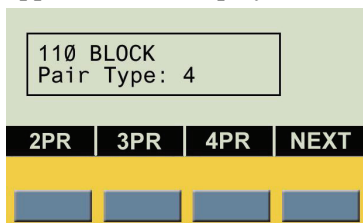

- Step 3.** To set or accept the pair configuration (**2PR**, **3PR**, **4PR**, or **5PR**), do one of the following:
- Press the **ENTER** key to accept the default (**4PR**), or
 - Press another pair configuration softkey and press **ENTER**.



Note: For instruction on using the *BLANK* selection, see *Blank Pair Type* on page 30.



Note: See also *Horizontal Serialization* on page 31 and *Backbone Serialization* on page 32.

If you make a 2PR, 3PR, 4PR, or 5PR selection (4PR appears by default), the 110-Block editor display screen appears with the label type title in the upper left corner. One zone is viewed and editable at a time. The zone availability is pre-defined and based on the pair configuration, thus fixed accordingly. For example, 2PR has 24 zones, 3PR has 16 zones, 4PR has 12 zones, 5PR has 10 zones, and BLANK has two zones (*see examples*):

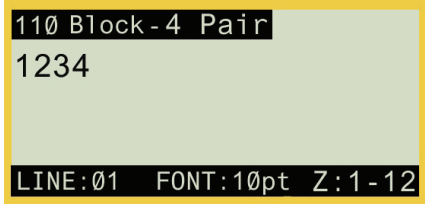

Display screen showing Zone 1 of a 4PR, 12-zone label

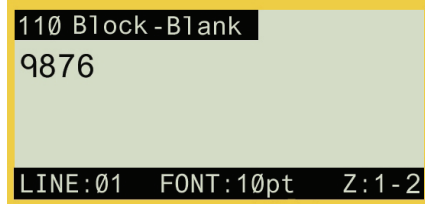

Display screen showing Zone 1 of a BLANK label type with two zones available

- Step 4.** Enter the label data into the desired zones, navigating between zones by pressing **FUNCTION + PREV ZONE** and/or **FUNCTION + NEXT ZONE** when entering data or when viewing or editing previously entered data.

BIX-Block Labels



Note: See *DataComm & T-Block Menu Selections* for a list of the high-level DataComm & T-Block Menu selections, their default values, and the corresponding softkeys.

This example outlines the functionality required to create a BIX-Block label using the DataComm & T-Block menu. BIX-Block labels print based on user-selected pair configuration. This example assumes use of a dedicated BIX-Block part (width = .625").

To create a BIX-Block label:

- Step 1.** Insert a dedicated part (.625" x continuous in B412 and B422). The printer reads the smart-cell settings and automatically displays the screen allowing you to choose between the General ID Menu and DataComm & T-Block Menu. Upon selecting the DataComm & T-Block Menu, the following datacomm menu options appear above the softkeys: **P-PNL, T-BLK, DESI, 110BLK, 66BLK, BIX.**



Note: To escape to the *General ID Menu* screen press **FUNCTION + CLEAR/ESC.**

- Step 2.** Press **NEXT**, then the **BIX** softkey. The default **BIX-Block** information automatically appears on the display screen as shown below (pressing **NEXT** advances menu options):

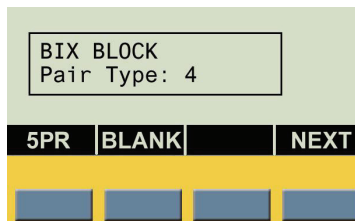
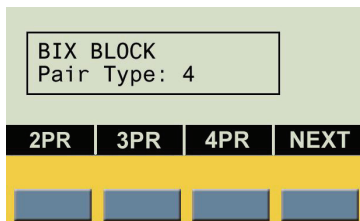

Step 3. To set or accept the pair configuration (**2PR**, **3PR**, **4PR**, or **5PR**), do one of the following:

- Press the **ENTER** key to accept the default (**4PR**), or
- Press another pair configuration softkey and press **ENTER**.



*Note: For instruction on using the **BLANK** selection, see **Blank Pair Type** on page 30.*



*Note: See also **Horizontal Serialization** on page 31 and **Backbone Serialization** on page 32.*

If you make a 2PR, 3PR, 4PR, or 5PR selection (4PR appears by default), the BIX Block editor display screen appears with the label type title in the upper left corner. One zone is viewed and editable at a time. The zone availability is pre-defined and based on the pair configuration, thus fixed accordingly. For example, 2PR has 24 zones, 3PR has 16 zones, 4PR has 12 zones, 5PR has 10 zones, and BLANK has two zones (*see examples*):

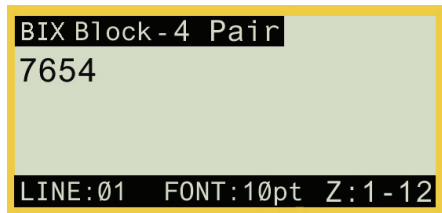

Display screen showing Zone 1 of a 4PR, 12-zone label

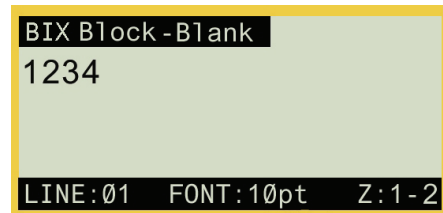

Display screen showing Zone 1 of a BLANK label type with two zones available

Step 4. Enter the label data into the desired zones, navigating between zones by pressing **FUNCTION + PREV ZONE** and/or **FUNCTION + NEXT ZONE** when entering data or when viewing or editing previously entered data.

Desi Strips



*Note: See **DataComm & T-Block Menu Selections** for a list of the high-level DataComm & T-Block Menu selections, their default values, and the corresponding softkeys.*

This example outlines the functionality required to create a Desi Strip using the DataComm & T-Block menu.

To create a Desi-Strip label:

Step 1. Insert a dedicated part (.375" x continuous in B412). The printer reads the smart-cell settings and automatically displays the screen allowing you to choose between the General ID Menu and DataComm & T-Block Menu. Upon selecting DataComm & T-Block Menu, the following datacomm menu options appear above the softkeys:
P-PNL, T-BLK, DESI, 110BLK, 66BLK, BIX.



*Note: To escape to the **General ID Menu** screen press **FUNCTION + CLEAR/ESC**.*

Step 2. Press the **DESI** softkey. The *Desi-Strip* information automatically appears on the display screen as shown below (in inches or millimeters, depending on user settings*):

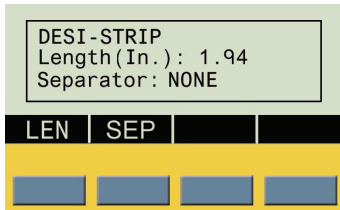

*See **Setting Units** on page 36 for instruction on setting units to inches or millimeters.

Step 3. To set or accept the length, do one of the following:

- Press the **ENTER** key to accept the default, or
- Press the **LEN** softkey, enter a new length, and press **ENTER**.



Note: From this point, similar functionality is used as when working with Patch Panels. See **Patch Panel Labels** on page 23 for more information.

Desi-Strip display screen examples:



Display screen before text/zones entered

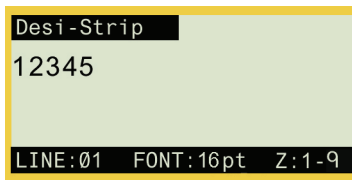

Display screen showing nine-zone label with the first of nine zones displayed

Blank Pair Type

If you select BLANK instead of a 2PR, 3PR, 4PR, or 5PR configuration (using 110-Block or BIX-Block labels), you will move to the DataComm & T-Block menu, allowing you to enter characters into each empty (blank) zone. The zone availability is pre-defined as two zones covering the printable length of the strip.

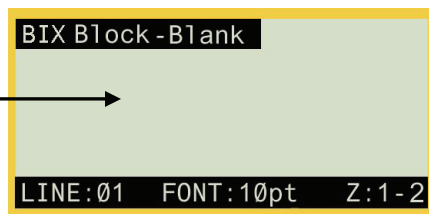
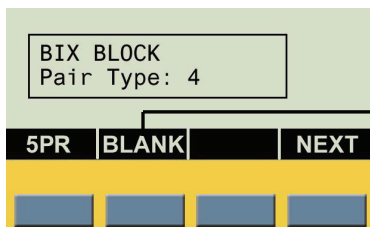
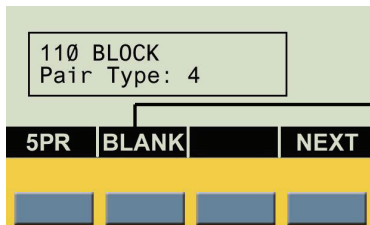

Blank Pair Type Example

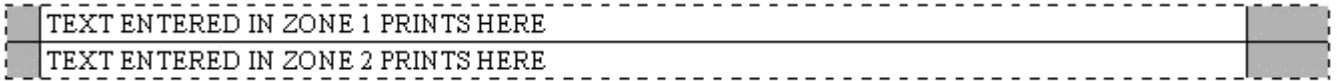

- The “Blank” strip will be formatted as two zones covering the full *printable* length of the strip (7.5" with a *total* strip length of 7.9" for 110-Block labels; 6.2" with a *total* strip length of 6.6" for BIX-Block labels).
- One line of text is allowed on each zone. Pressing **FUNCTION + NEXT ZONE** while the cursor is on the first line (to be printed in the top zone) will move the cursor to Line 2 (which will be printed in the bottom zone).
- Horizontal Justification default = Left; Vertical Justification default = Center.
- You may enter up to a maximum of 75 characters per zone.

Horizontal Serialization

After creating 110-Block or BIX-Block labels, you can perform horizontal serialization of the labels by doing the following:

- Step 1.** Enter the alpha and/or numeric characters to be serialized.
- Step 2.** Use the arrows on the keypad [◀] [▶] (right/left) to position the cursor under the character to be serialized.
- Step 3.** Press **SERIAL** on the keypad. Horizontal (**HORIZ**) and Backbone (**BBONE**) softkey options appear:

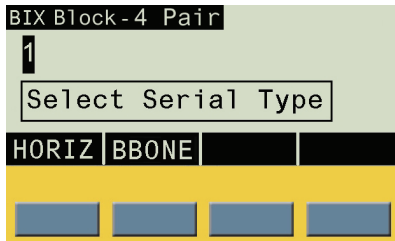

- Step 4.** Press the **HORIZ** softkey.
- Step 5.** Enter the desired number of strips (1–9 value only) and press **ENTER**. (The default number is “1”— the example below shows “5” entered.) Printing begins.

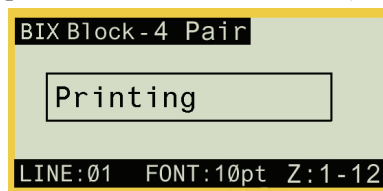
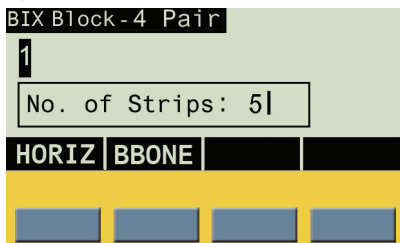

Note: After printing a series of serial characters, the display screen shows the next logical character in the serial pattern. (Example: After printing 1 to 5 and print job is completed, display screen shows 6.)

Horizontal Serialization Examples (110-Block and BIX-Block Labels)

The default justification is Center/Center; however, justification can be adjusted using the **JUST** (justification) softkey. **Note:** Examples below may not be drawn exactly to scale.



Note: Rotation cannot be adjusted on 110-Block or BIX-Block labels.

Example—2 Pair

1	2	3	4	5	6	7	8	9	10	11	12	
13	14	15	16	17	18	19	20	21	22	23	24	

Example—3 Pair

1	2	3	4	5	6	7	8	
9	10	11	12	13	14	15	16	

Example—4 Pair

1	2	3	4	5	6	
7	8	9	10	11	12	

Example—5 Pair

1	2	3	4	5	
6	7	8	9	10	



Note: Non-printable zones are included on each end (0.2" at front end of strip, remainder at end of label, varied depending on pair type).

Backbone Serialization

To perform backbone serialization, follow the first three steps for performing *Horizontal Serialization*, then do the following:

Step 1. Press the **BBONE** softkey.

Step 2. Enter a numeric (0–9) start value (three digits maximum value) and press **ENTER**.



Note: Any characters previously entered via the DataComm & T-Block Menu will be overwritten.

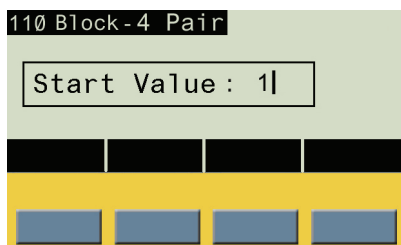

Step 3. Enter the desired number of strips (1–9 value only) and press **ENTER**.
Printing begins automatically.

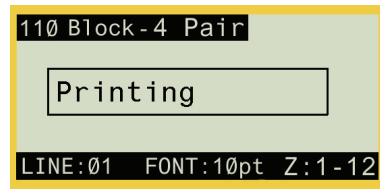
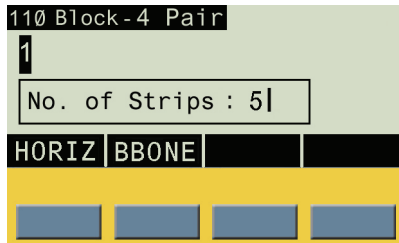

Note: After printing a series of serial characters, the display screen returns to the DataComm & T-Block menu mode to the display last edited before serialization. Pressing **FUNCTION + CLEAR/ESC** exits the DataComm & T-Block menu and returns to General ID menu mode.

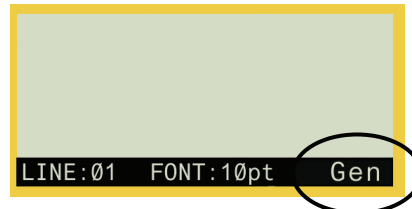
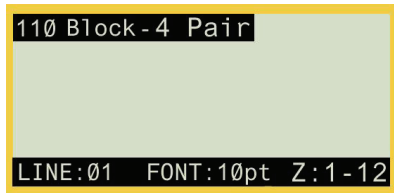

WARNING: 110-Block labels in backbone serialization mode cannot be saved or recalled. The message, “**Cannot Save**” displays as a reminder.

Backbone Serialization Examples (110-Block and BIX-Block Labels)

The leftmost zones on each strip print with two numbers. The first number is left-justified; the second number is right justified. All other zones print with one right-justified number. **Note:** Examples below may not be drawn exactly to scale.



Note: Rotation cannot be adjusted on 110-Block or BIX-Block labels.

Example—2 Pair

1	2	4	6	8	10	12	14	16	18	20	22	24
25	26	28	30	32	34	36	38	40	42	44	46	48

Example—3 Pair

1	3	6	9	12	15	18	21	24
25	27	30	33	36	39	42	45	48

Example—4 Pair

1	4	8	12	16	20	24
25	28	32	36	40	44	48

Example—5 Pair

1	5	10	15	20	25
26	30	35	40	45	50



Note: Non-printable zones are included on each end (0.2" at front end of strip, remainder at end of label, varied depending on pair type).

Chapter 7 General Settings

This chapter provides information on general settings. Settings for the IDXPERT™ Handheld Labeler are set using the **General ID Menu** and corresponding softkeys.

Setting the Time/Date Stamp

The printer allows you to print a real time and/or date field on your labels. First you must set the time and date on the printer.

To set the time:

- Step 1.** Press **MENU**. 
- Step 2.** Press **NEXT** twice, then press **TIME**. The display screen shows the current time setting.

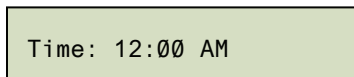

Time: 12:00 AM

- Step 3.** Press **HOUR** to cycle to the correct hour, and then **MIN** to cycle to the correct minute. Press **12/24** to toggle between 12/24 time format and hour/minute time format.

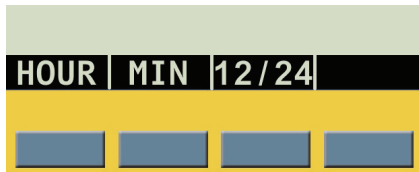

HOUR | MIN | 12/24

- Step 4.** Press **ENTER**. 



*Note: Pressing **FUNCTION** + the fourth softkey while in the **TIME** menu toggles lock/unlock access for changing the time manually.*

To set the date:

- Step 1.** Press **MENU**. 
- Step 2.** Press **NEXT** twice, then press **DATE**. The display screen shows the current date setting.

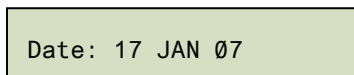

Date: 17 JAN 07

- Step 3.** Press the following softkeys to cycle to the correct month, day, or year:
- DAY**—cycles to the correct day.
 - MON**—cycles to the correct month.
 - YEAR**—cycles to the correct year.



- Step 4.** Press **ENTER**. 



*Note: Pressing **FUNCTION** + the fourth softkey while in the **DATE** menu toggles lock/unlock access for changing the time manually.*



Printing the Time/Date Stamp

To print the TIME stamp:

Press **FUNCTION**  +  (**INSERT TIME**). If the time stamp fits on your label, the time symbol  appears in the place in which you have your cursor. If it does not fit, you will receive this error message: “Cannot Fit.”

The time prints on your label in 12-hour, AM/PM format, for example, 1:30 PM or in 12/24 (military time) format, for example, 13:30.

To print the DATE stamp:

Press **FUNCTION**  +  (**INSERT DATE**). If the date stamp fits on your label, the date symbol  appears in the place in which you have your cursor. If it does not fit, you will receive this error message: “Cannot Fit.”

The date prints on your label in dd/MON/yy format. For example, 17/JAN/07.



***Note:** The time and date stamp reflects real time. Therefore, the time and date printed on a label reflects the time at **printing** (unless you have toggled unlock access for changing the time or date manually).*

Setting Units

The printer allows you to view both label measurements and font sizes in a variety of units.

To change default units:

- Step 1.** Press **MENU**. 
- Step 2.** Press **NEXT**, then press **UNIT**.
- Step 3.** Select default units. The display screen shows the current unit settings.

Label Units: Inches
Font Units: Points

- To change the default unit for label measurements, press **LABL**, then press **INCH**, or **MM**.
- To change the default unit for fonts, press **FONT**, then press **POINT**, **INCH**, or **MM**.
Inches, millimeters, and points refer to the *height* of a character.

- Step 4.** Press **ENTER**. 

Setting Language

The printer allows you to view menu choices in 11 different languages.

To set the default language:

Step 1. Press **MENU**. 

Step 2. Press **NEXT** twice, then press **LANG**. The display screen shows the current language setting.

Language: English

Step 3. Select your default language.

To select this language	Press
English	ENG
French	FRE
German	GER
Dutch	DUT
Italian	ITAL
Portuguese (Brazilian)	PORT
Spanish	SPAN
Danish	DAN
Finnish	FIN
Norwegian	NOR
Swedish	SWE

Step 4. Press **ENTER**.



Note: All menu prompts and messages will be displayed in the language selected.



Chapter 8 Advanced Features

This chapter provides information on creating and printing continuous labels (both automatic and fixed length), zones on labels, general serialized labels, and barcode labels.

Continuous Media

The printer's continuous setting allows you to create labels for a variety of applications including pipe markers, terminal blocks, and patch panels.

To work with continuous media:

- Step 1.** Press **MENU**. 
- Step 2.** Press **CONT**.
- Step 3.** Press **AUTO**, **LEN**, or **SEP**.
- Step 4.** Press **ENTER**. 

Auto

Auto is the default. When Auto is chosen, the characters entered determine the length of the continuous label up to a maximum of 75 characters or 19 in. (482mm), whichever is reached first. Font size and size of characters selected affect the maximum number of characters you can enter.

Length

The printer allows you to specify a fixed length for your continuous label.

When you turn *Auto* off, you must select a length.

- To select a length, press **LEN**. The display screen allows you to type in a fixed length: Min. = .2", (5mm) Max. = 19" (482mm).



Note: To set a fixed length in inches, type two places after the decimal point. For example, to set a fixed length of .2", **type 20**. You do not need to type the decimal point.

Separator

In addition, you may select a separator type.

- To select a separator, press **SEP**, then press **NONE**, **TIC**, or **LINE**. The default value is **NONE** in **General ID Menu** mode.



Separator Examples:

Line Separation				Tic Separation			
123	124	125	126	123	124	125	126



Note: Press **FEED** after printing to advance any fixed length continuous label to the cut position.

Zones on Labels

Press **FUNCTION**  +  (**CREATE ZONE**) to split a label into multiple zones:
 Create up to three zones on general continuous material using the General ID menu. Create up to 12 zones on certain dedicated datacomm parts for Terminal Block, Patch Panel, Desi-Strip, 66-Block, and 110-Block labels using the DataComm & T-Block menu. The number of zones allowed on these dedicated parts varies with the part and user-defined application chosen.

To create a multi-zone label:

1. Insert a continuous label cartridge.



2. Enter characters for **Zone 1**.



3. Press **FUNCTION**  + 



Display screen shows you are in **Zone 2 of 2**.

4. Enter characters for **Zone 2**.







5. Press **FUNCTION**  + 



Display shows you are in **Zone 3 of 3**.

6. Enter characters for **Zone 3**.



Note: Pressing **FUNCTION**  +  or **FUNCTION**  +  toggles between zones, whether navigating to a previous zone during text/character entry or editing text/characters on a multi-zone label.

Example—

Toggled back to **Zone 2** after three zones are created:



Display shows user is in **Zone 2 of 3**.





Note: The **Create Zone** process is repeatable for a maximum of three zones using the **General ID Menu** (it is repeatable for up to 12 zones if using the **DataComm & T-Block Menu**). All characters entered into each zone using the **General ID Menu** are retained and can be saved to memory.

General Serialization of Labels

The printer allows you to perform basic alpha or numeric serializations. Serializing a character results in a series of labels that increment the character by either one number or one letter. **For example:**

Numeric Serialization when the serialized character is 3 .	123, 124, 125, 126...
Alpha Serialization when the serialized character is C .	ABC, ABD, ABE, ABF...

To create labels containing serialized data:

- Step 1.** Enter the text to be serialized on the desired legend line.
- Step 2.** Use the arrows on your keypad [◀] [▶] (left/right) to position the cursor under the character in the legend to be serialized.
- Step 3.** Press **SERIAL**.  The screen prompts you to enter the number of times to increment the serial number.
- Step 4.** Enter the number of times to increment the serial number.
- Step 5.** Press **ENTER**.  The screen prompts you to enter the number of *copies* of the serialization to print.

The following example shows **2 copies** of a numeric serialization when the serialized character is **3**:



- Step 6.** Enter the number of copies.

- Step 7.** Press **ENTER**. 

General Guidelines for Serialization

- Both lowercase and uppercase characters can be serialized.
- Serialized characters can be incremented only (cannot decrement).
- Serialized text is limited to one line and one sequence per label.
- The printer first serializes the character the cursor is highlighted on when  is pressed. When this character reaches its maximum value (9, z, or Z), the character immediately to the left is incremented, and the right most character cycles back to its minimum value (0, a, or A).
- Once a serialized character has reached its maximum value and the next character encountered to the left is a non-serializable character (such as a space, accented character, or symbol), the serial pattern cycles back to begin incrementing again from the rightmost serialized character.
- After printing a series of serial characters, the display screen shows the next logical character in the serial pattern (*Example: Print 1 to 5. After print job is completed, screen displays 6*).

Barcode Labels

The printer allows you to print Code 39 and Code 128 barcode labels (while in General ID Menu mode). Barcode heights are available in inches or millimeters. See *Setting Units* on page 36 for instruction on setting units to inches or millimeters. Barcodes are selectable on a line-by-line basis. Text and barcodes cannot be combined on the same line.

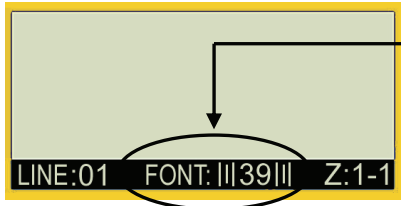

A barcode symbol in the status bar (on the display screen) indicates that a line is designated as a barcode.

Step 1. Press **MENU**.

MENU

Step 2. Press **NEXT** to navigate to and then press the **BAR** softkey. The following options appear:

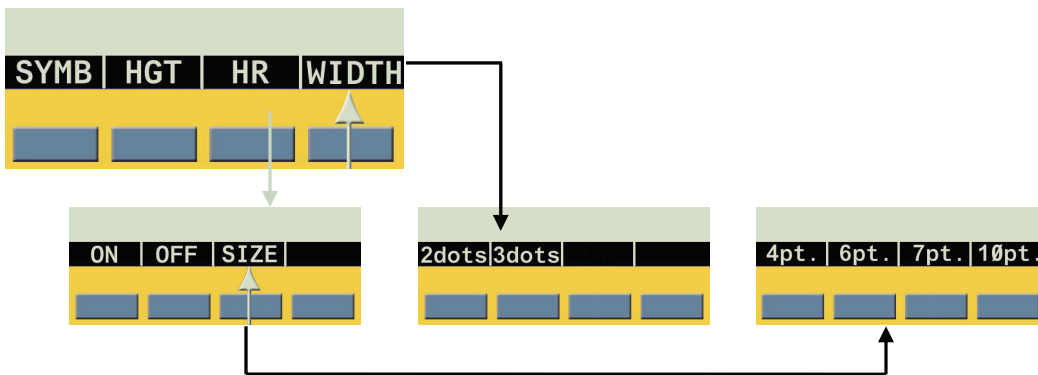

- **SYMB (Symbology)**
Select 39 (check digit on/off), or 128.
- **HGT (Barcode Height)**
Range is from .1" to 1.2"
Pressing the [▲] [▼] (up/down) softkey arrows raises and lowers barcode height in .1" increments.
- **HR (Human Readable)**
Select **ON**, **OFF**, or **SIZE**.
(**SIZE** provides font size options of 4pt., 6pt., 7pt., and 10pt.)
HR default font size = 10 pts
HR text is centered and positioned below the barcode.
- **WIDTH (Barcode Width)**
Available barcode widths are 2 dots and 3 dots.
Default barcode width is 3 dots.
- Pressing **FUNCTION** + **BARCODE** on the keypad toggles between text and barcode modes.

Step 3. After you complete selecting barcode formatting and entering data, press **ENTER**. The barcode will print with the human readable text centered below it.



Note: There are some data types such as symbols that cannot be entered or printed while in barcode mode. If you try to enter this type of information while in barcode mode, you will receive this error message: **“Cannot Fit”**

Barcode Display Screens

Each barcode format selection shows its current state individually on the display screen, and shows a list of the five major selections combined when you press **ENTER**.

Barcode Display Screen Examples:

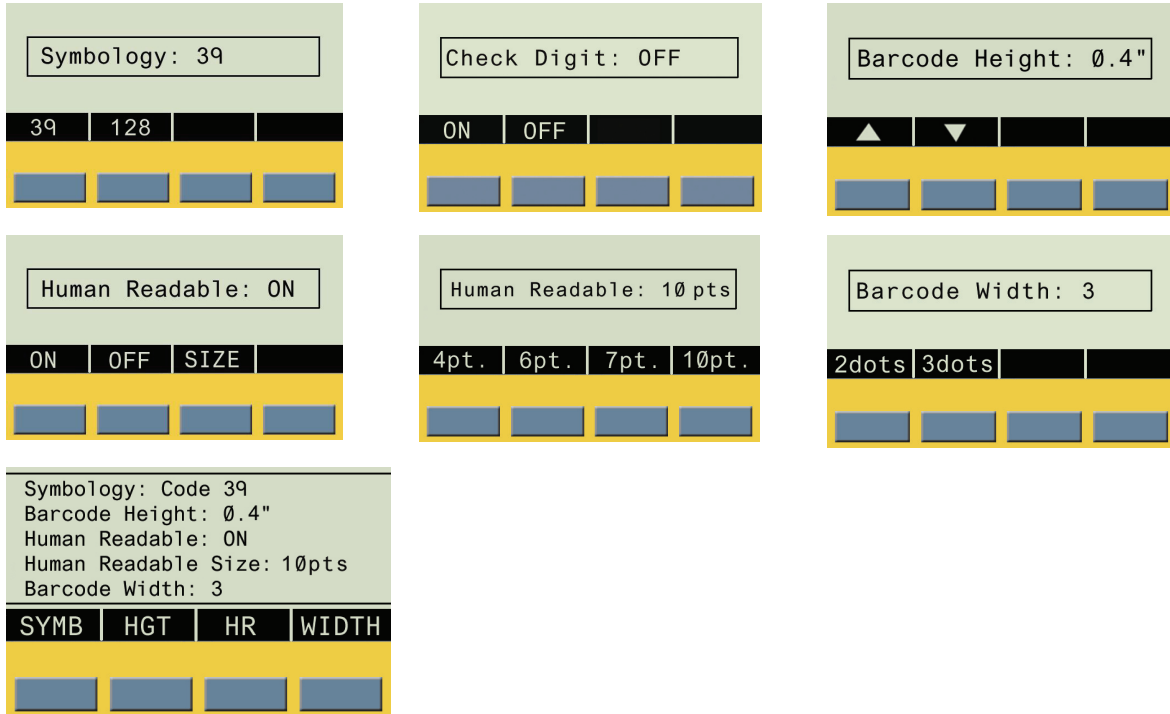

Note: See Appendix A—General ID Menu Tree for further menu detail.

Chapter 9 Memory

This chapter provides information for saving, retrieving, and deleting labels using the memory function.



Note: You can create, recall, edit, and save labels on your IDXPERT™ Handheld Labeler without a cartridge. Labels are created and saved based on the attributes of the last cartridge installed.

Saving a Label to Memory

You may save up to ten labels and then recall them for future use.

Step 1. Press **MEMORY**.



A grid appears showing **10 storage locations**. **Bold** numbers indicate storage locations that are occupied.

1	2	3	4	5
6	7	8	9	10
xc-1500-580				
ABC123				
SAVE	RCL	DEL		

Displays part name and first line of data for easy retrieval of the correct label.

Step 2. Use the arrows on your keypad—[▲] [▼]—to navigate to the desired storage location on the grid.

Step 3. Press the **SAVE** softkey. If you try to save the legend to an occupied space, you will get the option to overwrite it.

Recalling a Label from Memory

Step 1. Press **MEMORY**.



A grid appears showing **10 storage locations**. **Bold** numbers indicate storage locations that are occupied.

Step 2. Use the arrows on your keypad—[▲] [▼]—to navigate to the desired storage location on the grid. The part number (cartridge)—along with the first line of label text—shows on the display screen to help you identify the saved legend.

Step 3. Press the **RCL** softkey.





Caution: Pressing Recall will delete any text you have currently showing on the display screen.



Note: You must have a part number in the printer that is equal to or greater than (in print width and height) the part that was used when saving the legend. If the part number is too small, you will receive this error message: “**Cannot Fit**”

If you save a label using a new part number, it will be saved with the new part.

Deleting a Label from Memory

- Step 1.** Press **MEMORY**.  A grid appears showing **10 storage locations**. **Bold** numbers indicate storage locations that are occupied.
- Step 2.** Use the arrows on your keypad—[▲] [▼]—to navigate to the desired storage location on the grid. The part number (cartridge)—along with the first line of label text—shows on the display screen to help you identify the saved legend.
- Step 3.** Press **DEL**. A message appears asking if you are sure you want to delete the label.
- Step 4.** Press the **YES** softkey.
- Step 5.** Press **FUNCTION**  +  (**CLEAR/ESC**) to exit the memory function.

Chapter 10 Maintenance

This chapter provides instructions on cleaning your IDXPERT™ Handheld Labeler. It also includes an accessory parts list.

Cleaning

Follow these instructions to keep your printer running at optimal performance.

Step 1. Remove label cartridge.

Step 2. Use a cotton swab moistened with isopropyl alcohol and thoroughly wipe the following:



WARNING: Use a foam swab (with black handle) provided in your cleaning kit. See the *Accessories Parts List* on page 47.



WARNING: Wait five minutes after cleaning so the printer is dry before installing a cartridge.

- a. **Print head**—*Try cleaning the print head with a dry swab first.* Wipe the **print line** (black) area only. Do not wipe the green area.
- b. **Label exit slot**—Wipe the breaker bar located on the **inside** of the label exit slot. The cutter blade meets the breaker bar when a label is cut.
- c. **Deflector plate**—This is located above the print head, to the right of the platen roller. See the illustration on the following page.

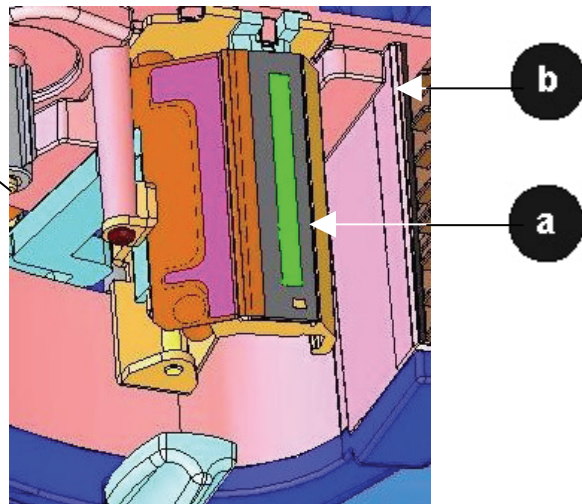
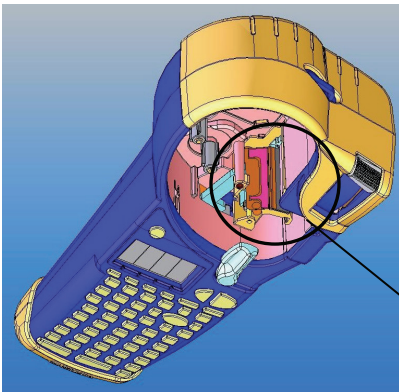

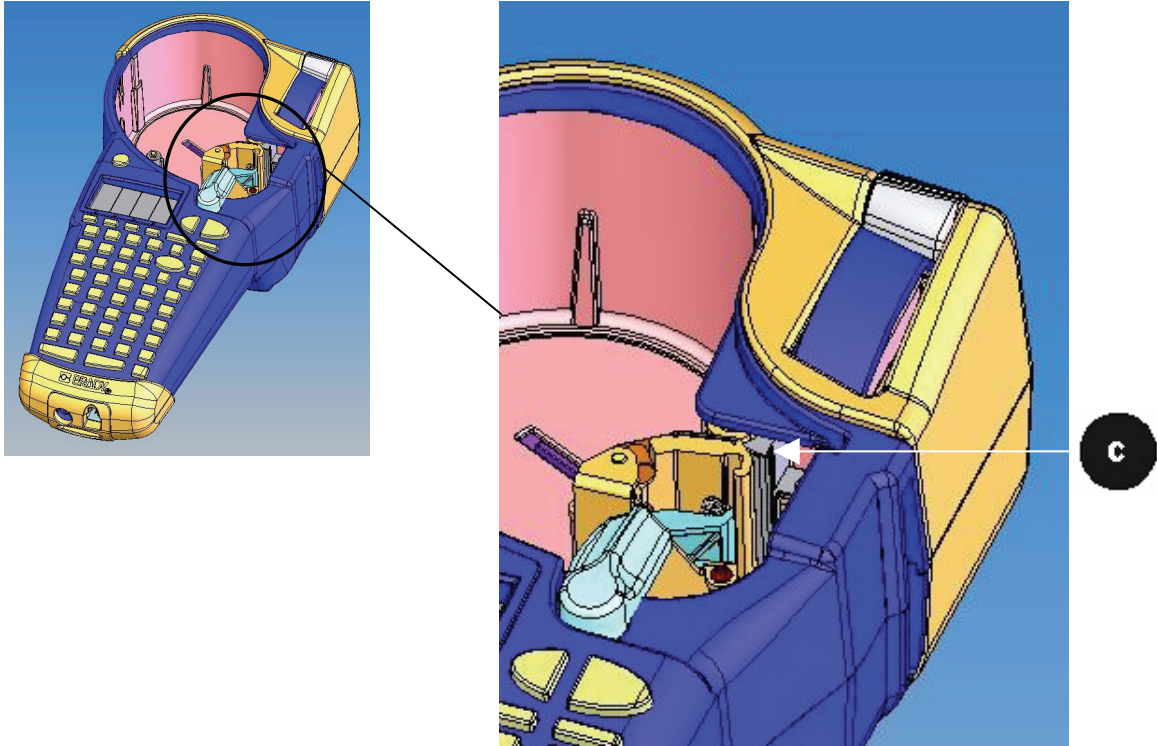

Accessory Parts List

Description	Catalog No.	*UPC Part No.
Hard side Carrying Case - ABC Keypad	XPERT-HC-ABC	60547
Hard side Carrying Case - Keyboard Layout	XPERT-HC-KEY	60548
AC Adapter - North America	XPERT-AC	60544
AC Adapter - Europe	XPERT-ACEUR	60545
AC Adapter - UK	XPERT-ACUK	60546
Communications Cable	PCCABLE-1	18574
Cleaning Kit	PCK-4	33969

***North America Only**

Chapter 11 Troubleshooting



If your IDXPERT[™] Handheld Labeler is not performing as documented in this user manual, use the following troubleshooting and error message guides to determine the corrective action you should take. If the corrective action does not work, contact Brady's Technical Support Group.

Troubleshooting Guide

Symptom	Cause	Corrective Action
Poor quality printing	The print head and platen roller are dirty.	Clean the printer. See Cleaning on page 46.
	Battery power is low.	Replace batteries.
	Wrinkled media.	Press  .
Printer does not power up when turned on	Dead Batteries	Replace batteries.
	No Batteries	Insert batteries.
	A/C adaptor not plugged in.	Ensure A/C adaptor is plugged into a proper outlet.
Printer will not feed labels	The leading edge of the media roll is uneven or torn (not a straight edge).	Use a pair of scissors to cut a straight leading edge on the marker roll.



WARNING: When cutting die-cut labels, make sure to cut in between labels. For continuous media, cut just before a notch. DO NOT cut into the notch!

Printer will not feed labels	The leading edge of the media roll is either out past the cartridge edge or has retracted back into it.	Ensure that the media roll edge is flush with edge of cartridge and under the material guides.
Printer will not feed labels	Notch edges may be folded. Printer is not detecting a notch in the media.	Fold left edge back up so that the notch can be read.
Label material has retracted into cartridge	Excessive jarring during transportation of material.	Ensure that retention label is reapplied when storing the cartridge.
Fixed length label text gets cut off	 was not pressed before cutting.	Press  to move the fixed length label to the cut position.
Label material jams in printer	Retaining label was not removed.	Remove retaining label from cartridge before inserting into printer.

Error Messages

Error Message	Cause	Corrective Action
Head Open	The printer head mechanism is not engaged.	Lock the cartridge locking lever.
Out of Labels	The printer label cartridge is empty.	Install a new label cartridge. See <i>Replace material cartridge</i> on page 7.
No Cartridge	A cartridge is not inserted into printer.	Install a label cartridge. See <i>Replace material cartridge</i> on page 7.
Cannot Fit	The printable information will not fit on current label.	Either reduce the font size of the label data, or use a larger label size.
	The legend rotation was changed and the existing text will no longer fit.	Reduce the font size of the label data, change the rotation, or use a larger label size.
	The currently installed label is too small for legend retrieval.	Install a cartridge containing larger labels. See <i>Replace material cartridge</i> on page 7.
Invalid Label	The printer cartridge is not valid.	Install a new label cartridge. See <i>Replace material cartridge</i> on page 7.

Appendix A General ID Menu Tree

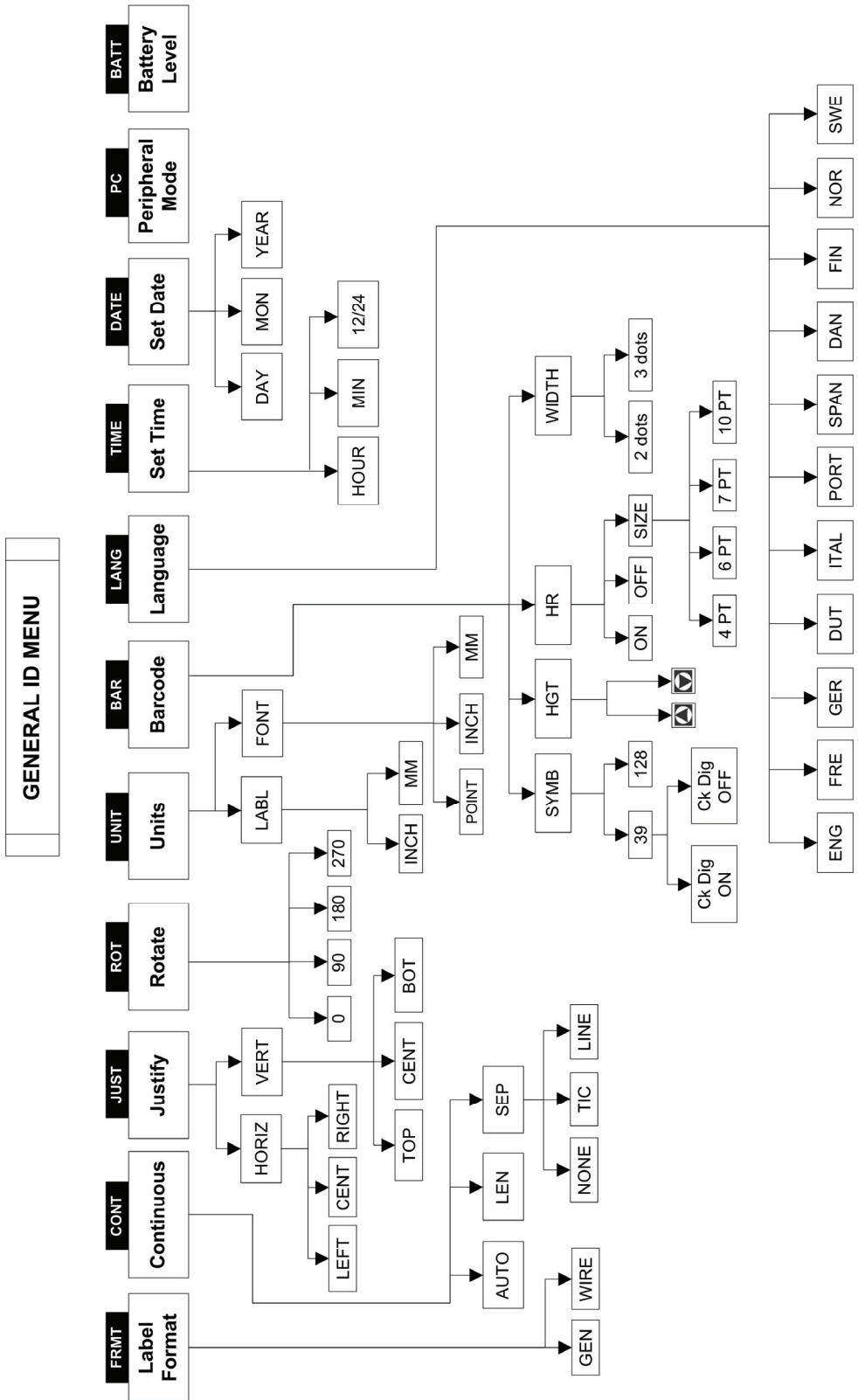

Appendix B DataComm & T-Block Menu Tree

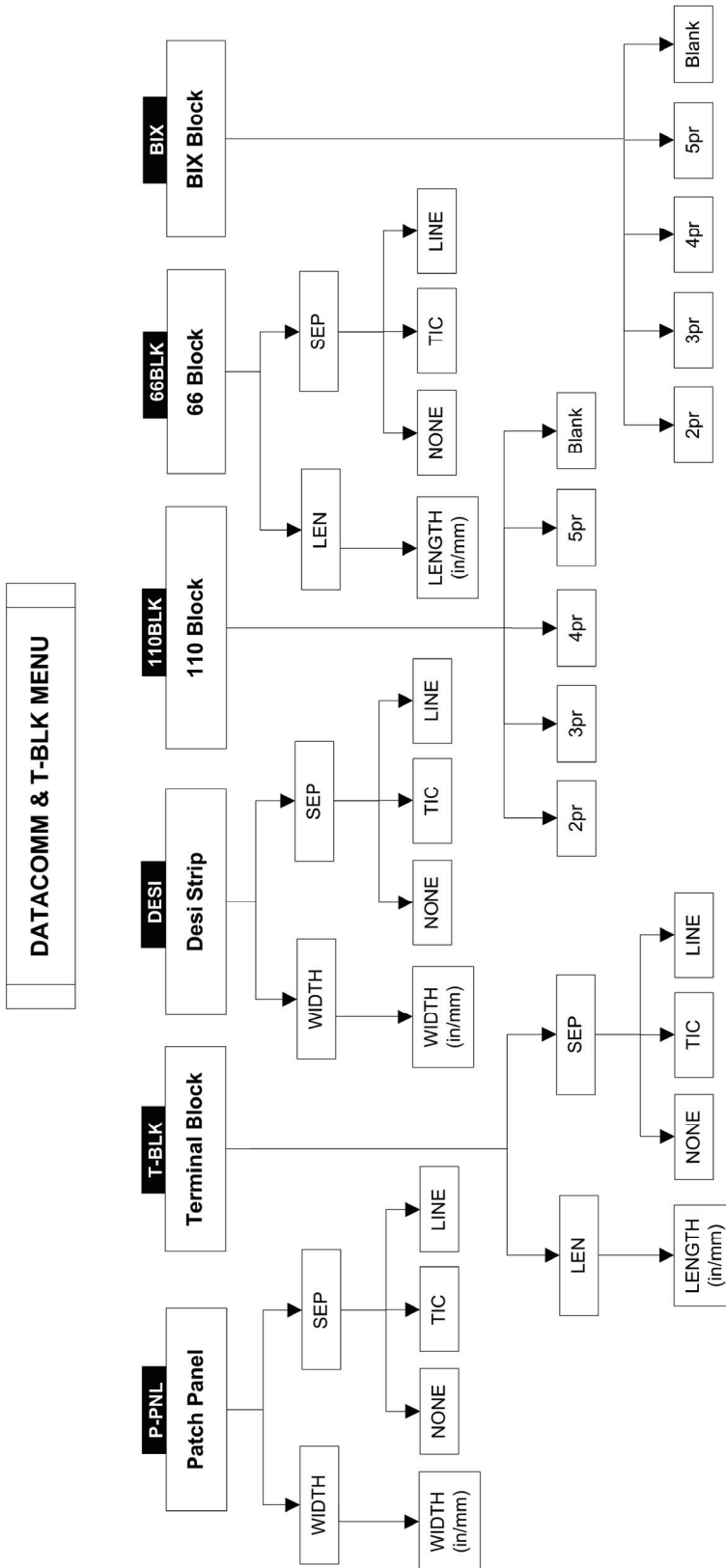

Note: ROT JUST Press [MENU] to access these final menu options after all menu selections are entered into the editor. The rotation [ROT] option is unavailable for 110- and BIX-block labels.

Note: HORIZ BBONE After setting up 110-Block or BIX-Block labels, press [SERIAL] on the printer keypad. Horizontal (HORIZ) and Backbone (BBONE) softkey menu options (and applicable screen prompts) appear for these two label types only.

Appendix C Font Size Chart

Point Size	Inch	Mm	Print Sample
4	.04	1.0	BRADY 12345
6	.05	1.3	BRADY 12345
7	.06	1.5	BRADY 12345
9	.09	2.3	BRADY 12345
10	.10	2.5	BRADY 12345
13	.13	3.3	BRADY 12345
16	.16	4.1	BRADY 12345
20	.20	5.1	BRADY 12345
26	.25	6.4	BRADY 12345
32	.31	7.9	BRADY 12345
38	.38	9.6	BRADY 12324
42	.41	10.4	BRADY 12345
45	.45	11.0	BRADY 12345
51	.50	13.0	BRADY 12345

Point Size	Inch	Mm	Print Sample
55	.54	13.7	BRADY 1234
60	.59	15.0	BRADY 123
65	.64	16.3	BRADY 12
70	.69	17.5	BRADY 12
76	.75	19.0	BRADY 1
102	1.00	25.0	BRADY

The IDXPERTTM Handheld Labeler also offers a 126 pt., (1.25", 33mm) font for UPPERCASE characters only.

Appendix D Symbol Library

See *Symbols* on page 18 for instructions on selecting and printing the symbols shown below:

Electrical / Voice Data							2
		\pm					
Greek	α	β	μ	ρ	Σ	Υ	Δ
	λ	Ω					
Mandatory/ PPE							
Warning							
Prohibition							
Fire / First Aid							
Haz Mat's (WHIMIS)							
*Arrows / Misc.						TM	€
	©		CE				

*Arrows are available in four rotations: 0°, 90°, 180°, and 270°.



Note: Some of the symbols listed above are accessible directly from the keypad.

Appendix E Glossary of Terms

It may be helpful to review these terms while using this manual:

Alphanumeric—Consisting of alphabetic, numeric, punctuation and other symbols.

Backing Material—The silicon-coated paper carrier material to which labels with adhesive backing are affixed. Also referred to as “liner.”

Bar Code—A representation of alphanumeric information in a pattern of machine-readable marks.

Cartridge (Material Cartridge)—Cartridge containing the label material, ribbon, and smart-cell.

Character Set—The entire complement of alphanumeric symbols contained in a given font.

Continuous Media (Labels)—Marking media in a continuous roll, *not* pre-cut or separated by spaces and notches.

Cutter—A mechanical device with a rotary or guillotine type blade used to cut labels or tags following printing.

Die Cut Media—Marking media that is pre-cut and separated into individual markers by spaces and notches.

Font—A set of alphanumeric characters that share a particular typeface.

Label—Once a marker contains printed text, it is referred to as a label.

Label Length—The distance from the top of the label to the bottom of the label as it exits the printer.

Label Width—The left to right measurement of the label as it exits the printer.

Legend—The actual text to be printed on a marker. The legend appears on the LCD screen and can be stored in memory.

Marker—A blank label. Until a label is actually printed, the material is referred to as a marker. Markers are available in a variety of sizes.

Serialize—To automatically print labels in a numeric or alphabetical sequence.